

Foreword

Thank you for choosing BYD. To better use and maintain the vehicle, please read this manual carefully and keep it for future reference.

Special instructions: BYD Auto Co., Ltd. recommends that you choose genuine spare parts and use, maintain, and repair the vehicle in accordance with this manual. The use of non-genuine spare parts to replace or modify the vehicle will affect the performance of the entire vehicle, especially its safety and durability. Vehicle damage and performance issues caused thereby will not be covered by the warranty. In addition, vehicle modifications may also violate national laws and regulations and local government regulations.

Thank you again for choosing BYD. Your valuable comments and suggestions are welcome. To enjoy better services, please provide your accurate contact information. If there is any change to the information, contact a BYD authorized dealer or service provider in a timely manner to update the information in the system. You are also advised to pay attention to the relevant national laws and regulations and local policies, and register the vehicle as soon as possible; otherwise vehicle registration may fail.

The descriptions marked with the asterisk (*) in this manual are specific to only some model configurations, and applicable only when the vehicle has these configurations. If there is any difference with the vehicle you purchased, the configuration of the actual vehicle shall prevail.

Pay attention to the "REMINDER", "CAUTION" and "WARNING" symbols in this manual, and follow the instructions carefully to avoid injury or damage. The hint types are defined as follows:

REMINDER

Items that must be observed to facilitate maintenance.

CAUTION

Items that must be observed to avoid damage to the vehicle.

WARNING

Items that must be observed to ensure personal safety.

 is a safety mark to indicate an operation that should not be performed or an event that should not happen.

This manual is expected to help you use the product correctly, and does not provide any description of the configuration and software version of this product. For details about the product configuration and software version, please refer to the contract (if any) related to this product, or consult the dealer who sold the product to you.

Everyone has the responsibility to protect the environment. Please use this vehicle properly and dispose of any waste and cleaning materials according to the corresponding local laws and regulations.

Copyright © BYD Auto Co., Ltd. All rights reserved.

No part of this document may be reproduced or transmitted in any form or by any means without prior written consent of BYD Auto Co., Ltd.

All rights reserved

Illustration Index

Exterior	7
Dashboard	8
Interior	9
Doors	10

Safety

Seat Belts	12
Seat Belts.....	12
Using Seat Belts.....	12
Airbags	15
Airbags.....	15
Driver and Front Passenger Airbags.....	16
Seat Side Airbags*.....	17
Side Curtain Airbags*.....	18
Airbag Triggering Conditions and Precautions.....	18
Child Restraint Systems	23
Child Restraint Systems.....	23
Anti-theft System	28
Anti-theft System.....	28
Data Collection and Processing	29
Data Collection and Processing.....	29

Instrument Cluster

Instrument Cluster	34
Instrument Cluster.....	34
Instrument Cluster Indicators.....	36

Controller Operation

Doors and Keys	46
Keys.....	46

Locking/Unlocking Doors.....	48
Smart Access and Start System.....	55
Child Protection Lock.....	57
Seats	58
Seat Precautions.....	58
Adjusting Front Seats.....	58
Folding Rear Seats.....	60
Rear Seat Head Supports.....	61
Steering Wheel	62
Steering Wheel.....	62
Switches	65
Light Switches.....	65
Wiper Switch.....	68
Driver's Door Switches.....	69
Window Control Switch on Passenger Side.....	71
Odometer Switch.....	71
Mode Switches.....	71
Front Passenger Airbag Switch (PAB).....	72
Hazard Warning Light Switch.....	73
Emergency Call (E-Call)*.....	73
Interior Light Switch.....	74

Using and Driving

Charging/Discharging	76
Charging/Discharging.....	76
Charging.....	80
Discharging Device.....	87
Charge Port Anti-theft Lock.....	88
Driving Range Display.....	89
Energy Regeneration Settings.....	90
Battery	91
High-Voltage Battery.....	91
Low-Voltage Battery.....	93

Usage Precautions.....	94
Break-in Period.....	94
Trailer Towing.....	95
Driving Safety Precautions.....	95
Suggestions for Vehicle Use.....	96
Saving Energy and Extending Vehicle Service Life.....	97
Carrying Luggage.....	97
Wading into Water.....	98
Fire Prevention.....	99
Snow Chains.....	101
Starting and Driving.....	101
Starting the Vehicle.....	101
Remote Start*.....	103
Gear Shift Controls.....	103
Electronic Parking Brake (EPB)*.....	104
Automatic Vehicle Hold (AVH).....	106
Driving Precautions.....	107
Driver Assistance.....	109
Adaptive Cruise Control (ACC).....	109
Intelligent Cruise Control (ICC).....	113
Predictive Collision Warning (PCW) & Automatic Emergency Braking (AEB)	115
Front Cross Traffic Alert (FCTA)/ Front Cross Traffic Braking (FCTB).....	117
Traffic Sign Recognition (TSR).....	119
Intelligent Speed Limit Control (ISLC)..	120
High Beam Assist (HMA).....	121
Lane Departure Assist (LDA).....	122
Emergency Lane Keeping Assist (ELKA).....	124
Blind Spot Assist (BSA).....	125
Head-up Display (HUD)*.....	127
Tire Pressure Monitoring.....	128
Acoustic Vehicle Alerting System (AVAS).....	129

Panoramic View System.....	130
Parking Assist System.....	132
Driving Safety Systems.....	135
Intelligence Torque Adaption Control (iTAC) System*.....	139
Driver Attention Warning (DAW).....	139
Child Presence Detection (CPD).....	140
Other Main Functions.....	141
Interior Rearview Mirror.....	141
Power Side Mirrors.....	141
Wipers.....	142

In-Vehicle Devices

Infotainment System.....	146
Infotainment Touchscreen.....	146
A/C.....	147
A/C Panel.....	147
A/C Operation Interface.....	147
Function Definitions.....	149
Vents.....	151
Air Purification System.....	152
A/C Settings.....	154
Storage.....	154
Glove Box.....	154
Cubby Box.....	155
Cup Holder.....	155
Storage Box on Interior Panel.....	156
Bill Box.....	156
Seatback Pockets.....	156
Engine Compartment Storage.....	156
Other Devices.....	156
Sun Visors.....	156
Grab Handles.....	157
12V Auxiliary Power.....	157

USB Ports..... 157
 Wireless Phone Charger..... 158

Maintenance

Maintenance Information.....162
 Maintenance Cycle and Items.....162
Regular Maintenance..... 167
 Regular Maintenance..... 167
 Vehicle Corrosion Prevention..... 168
 Paint Maintenance Tips.....168
 Vehicle Cleaning.....169
 Interior Cleaning.....170
Self-Maintenance.....171
 Self-Maintenance..... 171
 Vehicle Storage.....173
 Hood..... 174
 Cooling System.....174
 Braking System.....175
 Washer..... 175
 A/C System.....176
 Wiper Blades.....176
 Tires..... 177
 Fuses..... 180

When Faults Occur

When Faults Occur..... 188
 Reflective Vest..... 188
 If Smart Key Battery Is Exhausted.....188
 Emergency Shutdown System.....188
 Vehicle Fire Rescue.....189
 Battery Leakage Rescue..... 189
 If the Vehicle Needs Towing..... 190
 If a Tire Goes Flat..... 191

If the Low-Voltage Battery Is Exhausted..... 193
 If the Vehicle Needs Support..... 194

Specifications

Data..... 198
 Vehicle Data..... 198
Information.....201
 Vehicle Identification..... 201
 Warning Labels.....202
 Transponder Mounting..... 203
Declarations of Conformity..... 203
 Smart Key..... 203
 MmWave Radars..... 204

Abbreviation List

Abbreviations..... 209

Illustration Index

Exterior

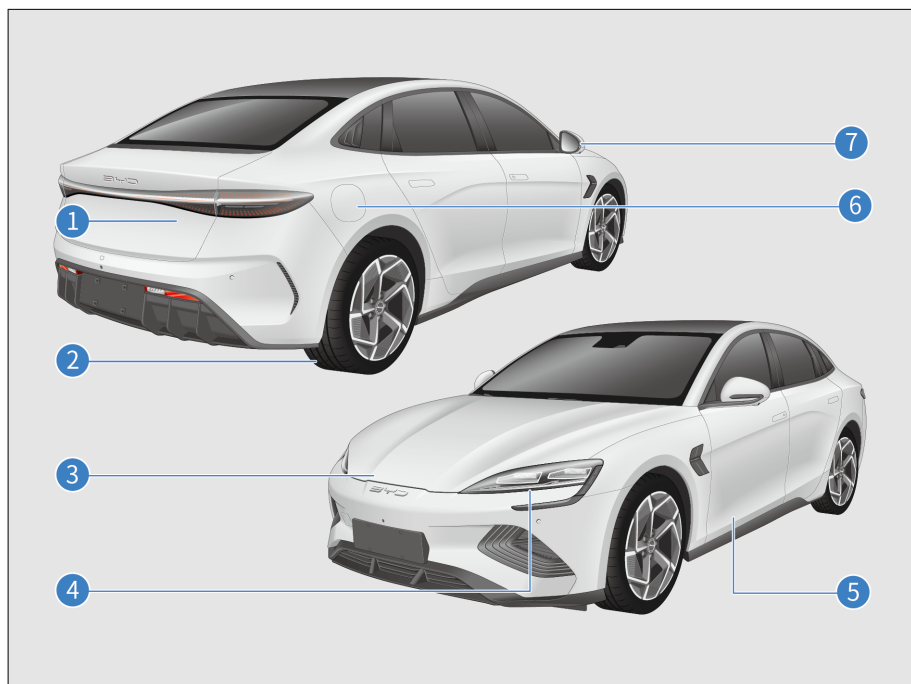

- | | | | |
|---|--|---|--|
| 1 | Trunk Lid P51
Carrying Luggage P97 | 5 | Doors P49
Locking/Unlocking P49 |
| 2 | Tire P177
Snow Chains P101
If a Tire Goes Flat P191 | 6 | Check Before Charging P80
Using Mode 2 Charging Cable* P80
Using AC Charging Piles* P83
Using AC Charging Piles* |
| 3 | Hood P174
Coolant P174
Washer System P175
Under-Hood PDB P181 | 7 | Power Side Mirrors P141
Folding Side Mirrors P142 |

Dashboard

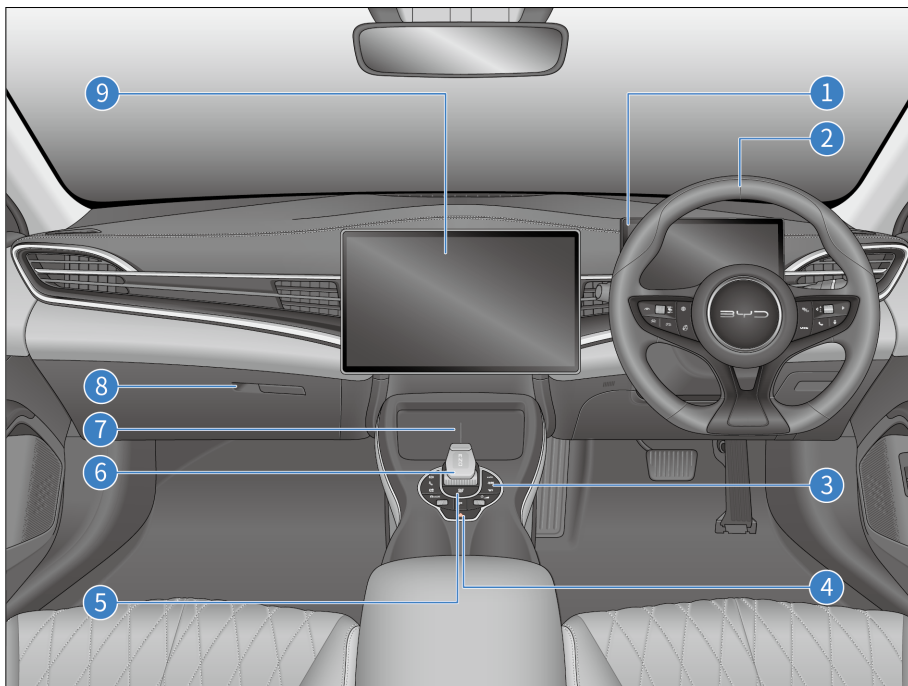

- 1 Instrument Cluster **P34**
- 2 Steering Wheel Manual Adjustment **P64**
- 3 A/C Panel **P147**
- 4 Hazard Warning Light Switch **P73**
- 5 START/STOP Button **P102**
- 6 Gear Shift Control **P103**
- 7 Wireless Phone Charging **P158**
- 8 Glove Box **P154**
- 9 Infotainment Control Panel **P146**

Interior

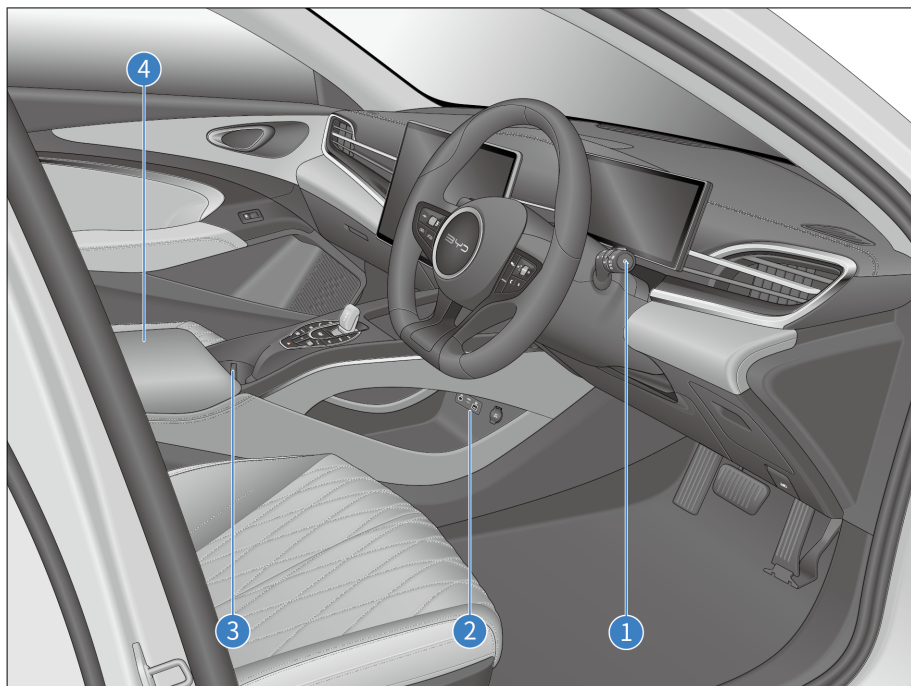

1 Odometer Switch **P71**

2 12V Auxiliary Power **P157**

USB Port* **P157**

3 Front Seat Cup Holder **P155**

4 Cubby Box **P155**

Doors

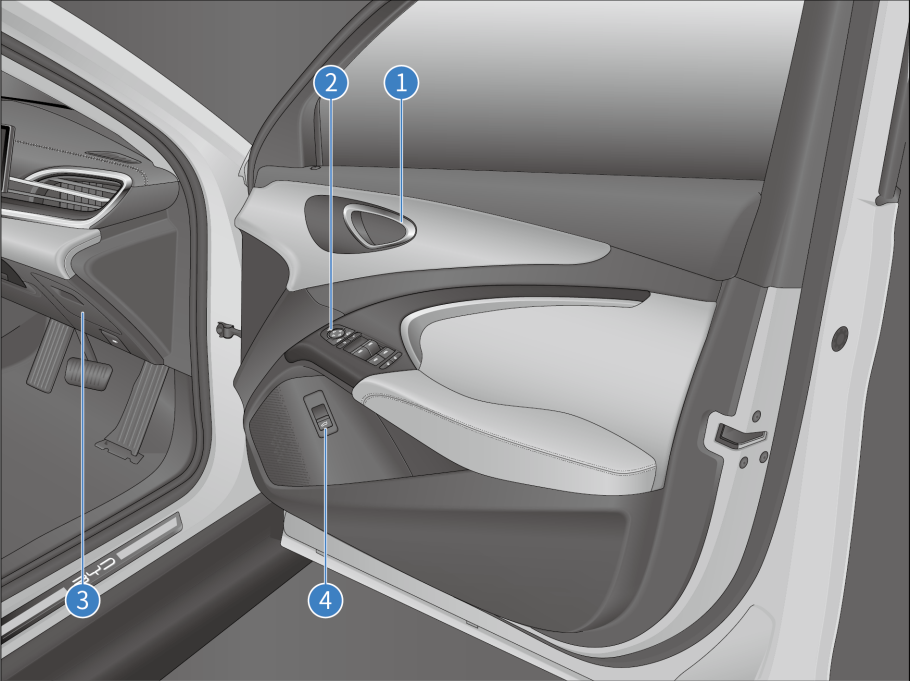

- 1 Opening with Interior Door Handle **P49**
- 2 Driver's Door Switches **P69**
- 3 Bill Box **P156**
- 4 Interior Trunk Switch **P51**

01

SAFETY

Seat Belts.....	12
Airbags.....	15
Child Restraint Systems.....	23
Anti-theft System.....	28
Data Collection and Processing.....	29

Seat Belts

Seat Belts

Studies have shown that proper use of seat belts can significantly reduce casualties in emergency braking, sudden steering or collisions. Please read the following information carefully and observe it strictly.

WARNING

- Always have the seat belts fastened while the vehicle is in motion.
 - Before driving, make sure all occupants are properly buckled up to prevent serious injury or death in emergency braking or in a collision.
 - The seat belts are designed primarily for adults and are not intended for children. Make sure to choose an appropriate child restraint system according to your child's age and size (see "Child Restraint Systems").
 - If a seat belt is damaged or malfunctions, immediately contact a BYD authorized dealer or service provider for confirmation and handling. Until then, do not use the corresponding seat.
- BYD has highly emphasized that all occupants should always fasten their seat belts while in the vehicle. Failure to do so increases the risk of injury in case of an accident.
 - It is recommended that children be seated in rear seats and always use seat belts and suitable child restraints. In emergency braking or

collision, unprotected children may be seriously injured and their lives may be endangered. Likewise, do not allow children to ride on someone's lap. This will render the children not adequately protected.

Seat Belt Emergency Locking Retractor (ELR) Function

- During the sharp turn, emergency braking and collision process, or when the occupant leans forward too quickly, the seat belt automatically locks to effectively restrain and protect the occupant.
- When the vehicle travels smoothly, seat belts are pulled out and retracted as the occupants move slowly and smoothly, allowing the occupants to move freely.
- If the seat belt locks due to sudden retraction, pull on the seat belt webbing to create retractable slack in order to pull out the seat belt.

Pretensioner and Force Limiter Function*

When a severe front collision occurs and the triggering conditions of the pretensioner are met, the pretensioner quickly retracts part of the seat belt and locks it to improve the protection of the occupant. The force limiter limits the seat-belt restraint force to the occupant's body to a certain extent so as to avoid injury to the occupant due to an excessive restraint force.

Using Seat Belts

1. Adjust the seat position and seatback angle. (see Adjusting Front Seats).
2. Adjust the position of the three-point seat belt.

- Keep the correct sitting posture and pull out the shoulder belt diagonally across the entire shoulder without contacting the neck or falling from the shoulder. Position the lap belt as low as possible around the hip.

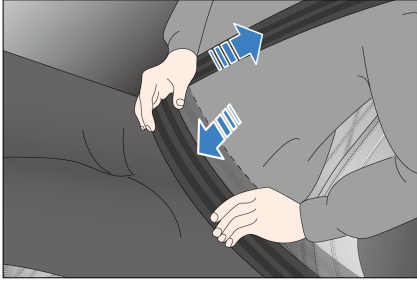

3. Insert the latch into the buckle until it clicks, and then pull it back to make sure it is firmly locked. Do not fasten the belt with any part of the strap twisted.

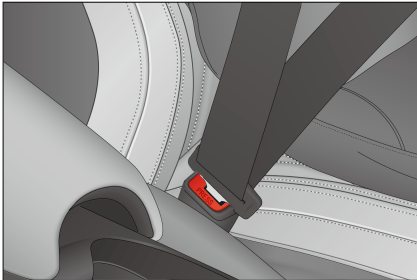

4. Adjust the height of the (front) seat belts for optimum comfort and protection.
 - ① Press the adjuster release button.
 - ② Move the adjuster up or down to the intended position. Release the button to lock the adjuster.

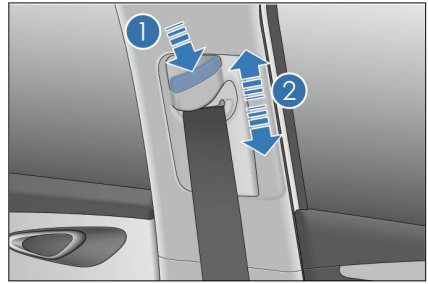

5. Pull the belt firmly to check that the adjuster is locked.

! WARNING

- The shoulder belt should cross the center of the shoulder. The seat belt should be far from the neck and not liable to slip from the shoulder, otherwise, it cannot function well in the event of emergency braking or accident, and may even cause severe injury.
- The lap belt should be positioned as low as possible around the hips to avoid serious injury due to the intense lap belt forces against the abdomen in an accident.
- The seat belt should be fitted tight to the body for better protection.

6. Unlock the seat belt.
 - Press the red unlock button on the buckle. The latch plate pops out, and the seat belt automatically retracts. If the seat belt does not retract smoothly and automatically, pull it out and check whether it is twisted.

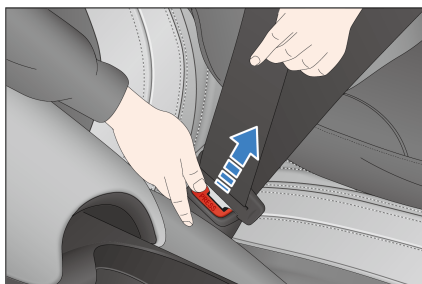

REMINDER

- The method of wearing a rear seat belt is the same as that for a front seat belt. For normal functioning of the rear seat belt, please ensure that its latch is inserted into the corresponding buckle during use. The driver should remind passengers to wear seat belts properly.
- The driver should ensure that all occupants are wearing seat belts before driving the vehicle.

WARNING

- Each seat belt should be used by one occupant only. Do not share a seat belt with another occupant, not even with a child.
- Avoid traveling with the seatback leaning too far back. The seat belt protection performs best when the seatback is upright.
- Make sure that no seat belt or its spring bolt/buckle becomes pressed by the door; otherwise, the seat belt may be damaged.
- Check the seat belts regularly for cuts, wear, looseness, and other abnormalities. If any problem is found, contact a BYD authorized dealer or service provider for confirmation and

WARNING

handling. Until then, do not use the corresponding seat.

- Do not remove, disassemble or modify the seat belts without permission.
- After an accident, have the seat belts checked at a BYD authorized dealer or service provider. If the preloading function is activated, the seat belt must be replaced.
- In the event of a serious accident, even if there is no apparent damage, the seat belt should be replaced along with the seat assembly. The airbag system should also be thoroughly inspected.
- Use an approved model whenever you replace the seat belt.
- Pregnant women should also fasten their seat belt properly. Particularly, be sure to position the lap belt as low across the hip as possible to prevent serious injury.
- Do not insert foreign objects such as coins and clips into the buckle as they prevent proper connection between the latch and buckle.

Seat Belt Reminders

If the driver, front passenger or rear passenger* has not buckled up after the vehicle is started, the alarm system goes off and continues until the corresponding seat belt is properly fastened.

- Seat belt reminder indicator
 - This indicator flashes if any seat's belt is not fastened.
- Display of unfastened belt's seat

- The indicator displays the corresponding position of the unfastened seat belt.
- Seat belt reminder for front passenger
 - If the driver or front passenger has not buckled up after the ignition is switched on, the seat belt reminder indicator and the indicator associated with the corresponding seat light up. If the seat belt remains unfastened while driving, in addition to the reminder indicator, an audible alarm is given to remind the driver and the occupant.
- Seat belt reminder for rear passengers*
 - With the ignition on, if any rear passenger does not buckle up, the seat belt reminder indicator and the indicator associated with the corresponding seat light up.
 - When the drive speed is above 20 km/h and only rear seats are loaded with occupant(s), who have not buckled up, the seat belt reminder indicator is on and an audible alarm is given.
- When the driver, the front passenger, and rear passengers have buckled up, the seat belt reminder indicator and all indicators displayed for the corresponding seats turn off.

WARNING

- In the event of abnormality or function failure, contact a BYD authorized dealer or service provider. Do not use the corresponding seat until the functions return to normal.
- When driving, make sure all occupants have their seat belts properly fastened to prevent serious injury or death in

WARNING

emergency braking or in a collision.

Airbags

Airbags

- The airbag system is a part of auxiliary restraint system and also a supplement to seat belts. When the vehicle is involved in a serious collision and the airbag system meets its deployment conditions, relevant airbags will rapidly deploy and, along with seat belts, provide additional protection for heads and chests of the occupants, to reduce likelihood of personal injury or even death.
- Airbags are divided into front and side types according to the type of collision. The front airbags include front occupant airbags, while the side airbags include seat side airbags and side curtain airbags.
- As an integral part of the vehicle's passive safety protection system, the airbag system does not replace seat belts and must be used in combination with seat belts to maximize protection.

Multi-Collision Braking (MCB)

- In the event of an accident, the automatic braking will be activated when the driver airbag or the front passenger airbag deploys.
- Speed reduction, along with intervention by additional driving systems (ESC and ABS), assists the vehicle to maintain stability and lane position.
- Hazard warning light and brake light would light up to warn oncoming

vehicles and aid to avoid secondary collision.

- The brake is released after an accident and brake lights are turned off to support emergency rescue or recovery of the affected vehicle.
- The driver can interrupt the multi-collision braking at any time by accelerating or braking.

WARNING

- Never seat a child in the front passenger seat.
- Occupants must sit in a proper position to maximize the protection provided by seat belts and the airbag system.
- Do not disassemble or assemble airbag components without authorization.
- If the seatbacks get wet from rain or splashes, the side airbag system may not work properly.
- Do not use seat covers, as they restrict airbag deployment on the corresponding side in an accident.
- Do not place anything between the side airbag and the occupant.
- Do not apply excessive force to the side of seats equipped with side airbags.
- After a collision, even if the airbag module did not deploy, and the pretensioner did not lock the seat belt, the airbag computer may be encrypted in order to protect occupants from high-voltage danger. Contact a BYD authorized dealer or service provider for inspection.

Driver and Front Passenger Airbags

If your vehicle is equipped with driver and front passenger airbags, when the electronic control unit (ECU) of the airbag system detects a moderate to severe front impact during driving and the triggering conditions are met, the airbags deploy.

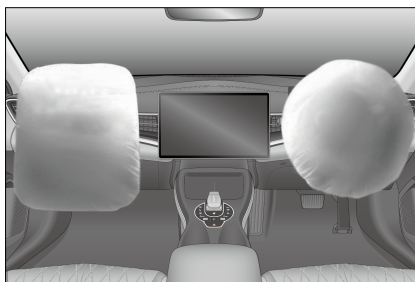

Front airbag deployment

- In moderate to severe frontal crashes, a sensor detects a sharp deceleration and sends a signal to the ECU to trigger the front airbags.
- When there is a frontal crash, the seat belt secures the occupant's lower body and torso in place. The airbag cushions and protects the occupant's head and chest.
- When the severity of the impact does not reach the airbag deployment threshold, seat belts provide enough protection.
- The front airbag deflates immediately after inflation, without affecting the driver's vision and ability to operate the steering wheel or other controls.
- Airbags can inflate rapidly when triggering conditions are satisfied to further protect drivers and occupants in an accident.
- A loud noise will be heard when the airbag deploys. It will not cause injury,

but it may cause tinnitus or temporary deafness.

- A cloud of dust from the airbag surface may come off when the airbag deploys. Although such powder is non-toxic, individuals with respiratory problem might experience some temporary discomfort.
- The front passenger airbag is controlled by the passenger airbag (PAB) switch. For details, see "PAB Switch*".

Seat Side Airbags*

If the vehicle is equipped with seat side airbags (mounted on the outside of seat back, marked with "AIRBAG" at both sides), when a moderate to severe side impact is detected during vehicle travel and the triggering conditions are met, the side airbag deploys to protect the occupant's chest.

Front passenger side airbags

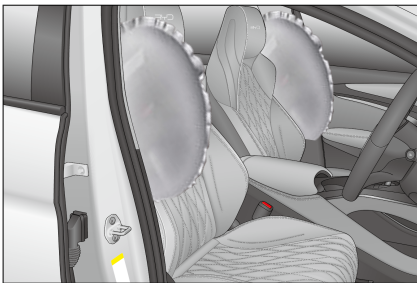

Rear passenger side airbags

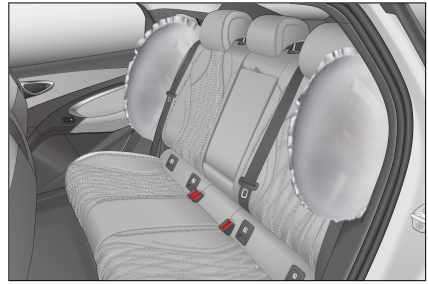

Seat side airbags starting process

- Generally only the airbag on the impacted side deploys in the event of a side impact.
- If the impact occurs on the passenger side, the airbag on the passenger side deploys even if there is no passenger in the seat.
- For optimal side airbag protection, occupants must have their seat belts fastened and sit upright against the seatback.

In a vehicle equipped with seat side airbags:

- Prevent the seatbacks from getting wet. If they get wet from rain or splashes, the side airbag system may not work properly.
- Do not cover or replace seatback covers on your own. Unsuitable seatback covers may prevent airbag deployment.

Front far side airbag:

- The vehicle is equipped with front far side airbags for the front seats (installed in the inner side edge of the driver seat and marked with "AIRBAG", as shown in the illustration).



- When a moderate to severe front or side impact is detected during vehicle travel and the triggering conditions are met, the far side airbag deploys to protect the heads and shoulders of the driver and the front passenger.
- If the impact occurs on the front passenger side, the far side airbag deploys even if there is no passenger in the seat.
- For optimal far side airbag protection, occupants must have their seat belts fastened and sit upright against the seatback.

Side Curtain Airbags*

If the model is equipped with left and right-side curtain airbags (mounted at the joint between the side walls of the body and the roof, with the A-pillar, B-pillar, and C-pillar shields marked with "CURTAIN AIRBAG"), as shown in the figure. When a moderate to severe side impact is detected during vehicle travel and the triggering conditions are met, the side airbag deploys to protect the occupant's chest.

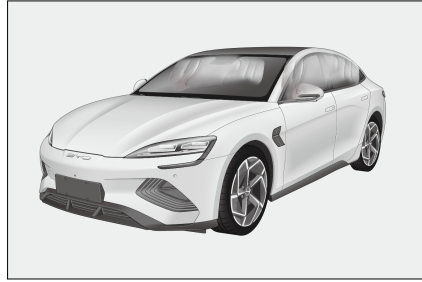

- Generally only the airbag on the impacted side deploys in the event of a side impact.
- For optimal side airbag protection, occupants must have their seat belts fastened and sit upright against the seat back.

Airbag Triggering Conditions and Precautions

Airbag Triggering Conditions

- The airbag triggering conditions are: In the event of a vehicle collision, whether an airbag will be triggered is decided by factors such as the amount of collision energy, accident type, collision angle, obstacles, and vehicle speed. The airbag system may be triggered in special collisions.
- The airbag system does not always work in any accident, and generally it will not be triggered in the event of a minor frontal collision, rear collision or rollover. In this case, the driver and passengers are protected normally by their properly fastened seat belts.
- Determinants of airbag system triggering: Decision is made by comparing the deceleration curve, generated in the collision and obtained by the Electronic Control Unit(ECU),

and the set value. If signals, such as the deceleration curve generated and measured in the collision, are lower than the respective reference values preset in the ECU, the airbag system will not be triggered even if the vehicle may have been seriously deformed in the accident.

- The ECU of the BYD airbag system has been set up with considerations of common misuse and road conditions. However, due to the increasing changes in causes and forms of vehicle collisions, for your safety, please strictly follow this user manual, use the vehicle correctly, and avoid its misuse. Otherwise, there is no guarantee that the airbags will achieve their expected effect.

Cases When Airbags May Be Deployed

The vehicle's nose hits the ground when crossing a deep groove.

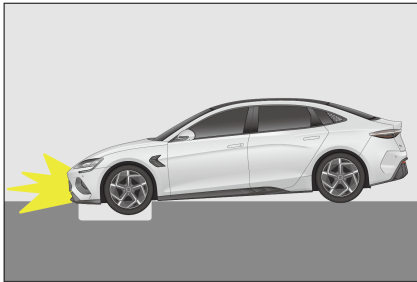

The vehicle hits a bump or curbstone.

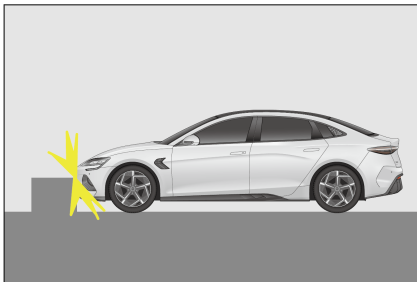

The vehicle's nose hits the ground when going down a steep slope.

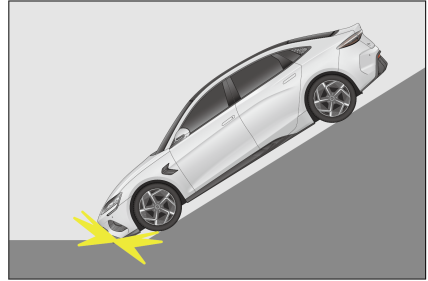

One side of the vehicle is hit by another vehicle.

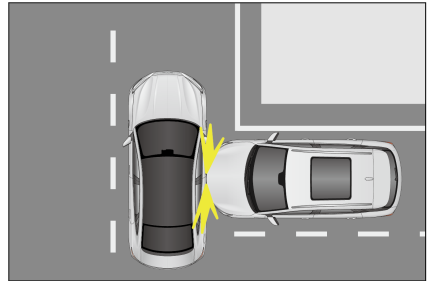

Cases When Airbags May Not Be Deployed

The vehicle hits a concrete column, tree, or other slim objects.

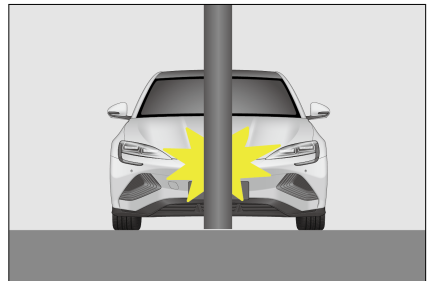

The vehicle goes under a truck or another large vehicle.

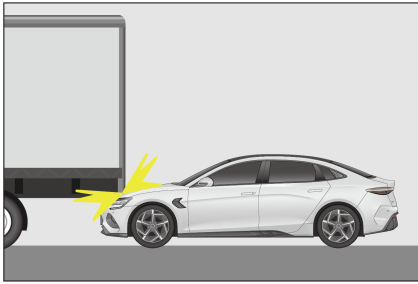

The tail of the vehicle is hit by another vehicle.

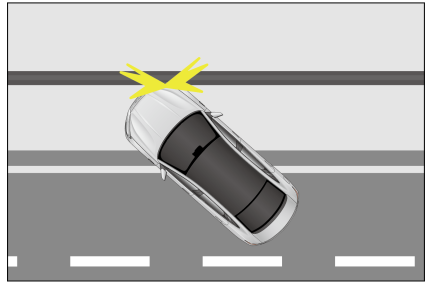

Parts other than the passenger compartment receive side impact.

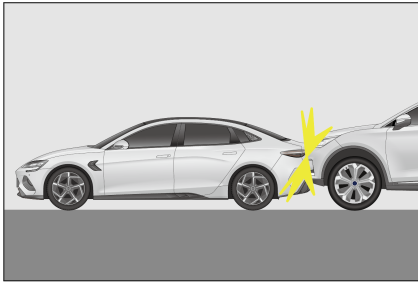

The vehicle rolls over.

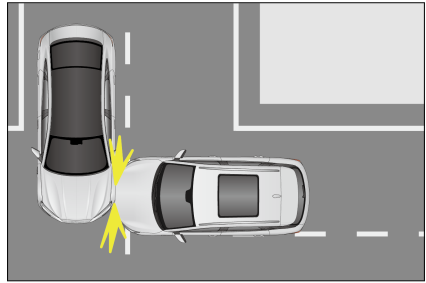

The lateral side of the vehicle is hit diagonally.

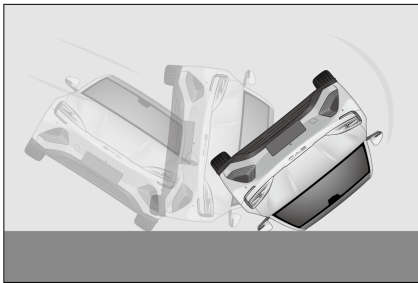

The vehicle hits a wall or a vehicle at a side other than the front.

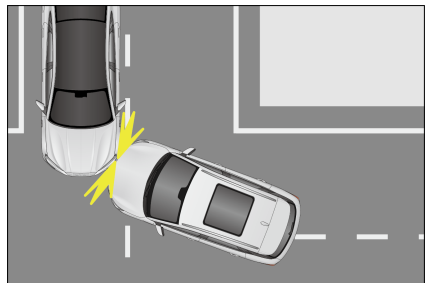

The lateral side of the vehicle hits a columnar object.

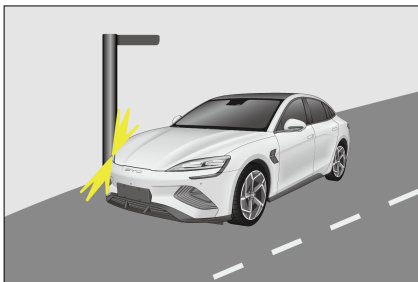

! WARNING

- Airbags are designed for specific models. Any changes to suspension, tire size, bumpers, chassis and factory-equipped devices may adversely affect the airbag system. Users must not use any parts of the airbag system on other car models; doing so may lead to failure of the airbag system.
- Drivers should maintain a distance of at least 25 cm between their chest and the steering wheel, in order for the system to provide the most effective driver protection.
- Fasten your seat belt and sit properly while the vehicle is in motion. If the seat belt is not fastened, and the occupant is leaning forward or sitting improperly, airbag deployment can increase the risk of injury.
- Do not paste stickers, cover or decorate the hub cover of the steering wheel, the right side surface of the dashboard or the surface of A, B and C pillar trims. Clean these surfaces with a dry or damp cloth, without applying too much pressure.
- A child is not to be seated without protection, nor are they to ride

! WARNING

sitting on a front passenger's lap, to prevent serious injury or even casualty caused by airbag deployment.

- No accessories, such as telephone holders, cups, ashtrays, may be installed on airbag covers or within their action range. Otherwise, airbag deployment will increase the risk of injury in an accident.
- Side airbags and side curtain airbags deploy quickly with high impact forces. Occupants must not lean against the doors of vehicles equipped with these airbags while these vehicles are in motion. Failure to do so could result in serious injury or even death.
- Do not place any other accessories or items within the action range of side curtain airbags, including the windshield, side door glass, A-pillar trim, ceiling, B-pillar trim, C-pillar trim and auxiliary handles. When the side curtain airbag deploys, the accessories or items will be thrown by the impact force from the side air curtain airbag, or the side curtain airbag may not deploy normally, resulting in serious injury or even death.
- When transferring vehicle ownership, make sure to pass on all of the vehicle's documents.
- Do not modify or replace seats or trims of the seats with side airbags. These changes may prevent normal deployment of side airbags, and thereby cause airbag system failure or unintended deployment of side

 **WARNING**

airbags, resulting in serious injury or death.

- Do not disassemble or repair the A-pillar trim, ceiling, B-pillar trim or C-pillar trim, which contain side curtain airbags. These changes can cause failure of the airbag system or accidental deployment of curtain airbags, which may cause serious injury or even death.
- Do not change any component of the airbag system, including any corresponding label. It is recommended that any operation done to the airbags be performed by a BYD authorized dealer or service provider.
- Airbags can only provide one-time accident protection. Once the airbag is triggered or damaged, the airbag system must be replaced.
- Follow safety regulations and procedures related to the scrapping of parts of the vehicle or its airbag system.
- The airbag system has strong anti-interference and anti-disturbance resistance to electromagnetic fields around it. However, to avoid accidents, do not use the vehicle in an electromagnetic environment that violates national regulations.
- The airbag system of this vehicle is designed with full consideration of domestic common misuses and road conditions. However, in order to avoid accidents, do not have the bottom of the vehicle impacted or drive roughly in harsh road conditions.

 **WARNING**

- This vehicle's airbag system has been fully verified to seamlessly match the vehicle's original wiring harness system. Any wiring harness modification or alteration may cause the airbags to deploy mistakenly under normal conditions or fail to deploy in the event of a collision.

It is recommended that you contact a BYD authorized dealer or service provider immediately if any of the following situations occurs.

- The airbag has deployed.
- Instrument cluster airbag warning light  lights up abnormally.
- There is a collision with the front of the vehicle (highlighted area shown), but the airbags do not deploy.

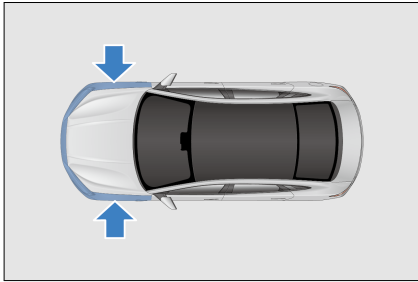

- The airbag cover (highlighted area shown) has been scratched, cracked or otherwise damaged.

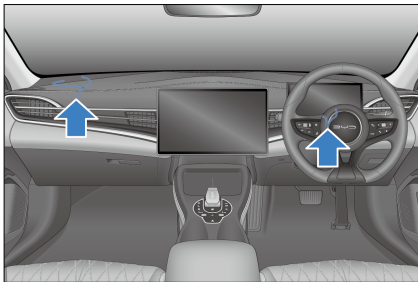

- Airbags need to be removed, disassembled, installed or repaired.
- Side airbags and curtain airbags have deployed.
- An impact to a vehicle door in an accident is not adequate to cause the airbag to deploy.

- The surface of the seat with a side airbag is scratched, cracked, or damaged similarly.
- Decorative (liner) parts at A-pillar with built-in curtain airbags, roof beam and C-pillar are scratched, cracked, or damaged similarly.

Child Restraint Systems

Child Restraint Systems

Child restraint systems provide good protection to your child in an accident. For the child's safety, please carefully read the instructions provided with the child restraint and in this manual before installing a child restraint.

WARNING

- Never carry a child on your lap in a vehicle journey.
- An appropriate child restraint system must be used for your child.
- Please follow the instructions provided with the child restraint system and in this manual to make sure the child restraint is properly installed in the vehicle.
- After the child restraint is dismantled from the seat, store it safely in your vehicle.
- Failure to follow the instruction provided with the child restraint and in this manual may cause injuries and even death to your child in an accident.

Children must use a suitable child restraint when traveling in the vehicle.

Children should sit comfortably and safely. Make sure that the child restraint is positioned, mounted, and used correctly.

Important considerations for selecting a child restraint system

- The child restraint system is the correct type and size for the child.
- The child restraint system is the correct type and size for the seating position.
- The child restraint system must be homologated by ECE R44/ECE R129.

Child Restraint System Anchorages

Rear outboard seat

- The anchorage is provided on the rear outboard seat, and it will only be visible after pressing its decorative cover (the label showing the anchorage is attached to the seat).

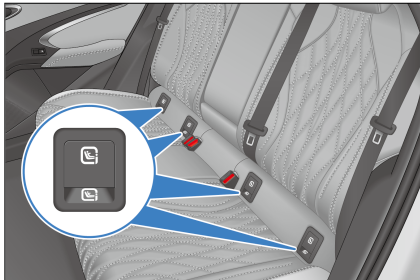

- Anchor supports (for the top tether) are provided at the rear outboard seat.

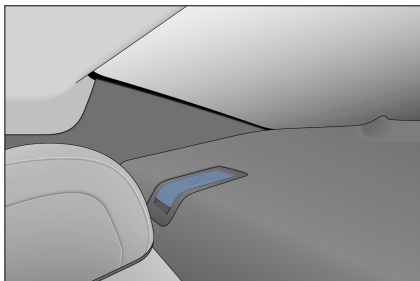

⚠ CAUTION

- Secure the top tether when installing the CRS.

Installing Child Restraint Systems

Precautions

- ① Do not turn the anchorage lever trim cover outward.
- ② Push the anchorage lever trim cover inward in use.
- ③ Press the upper part of anchorage lever trim cover to reset after use.

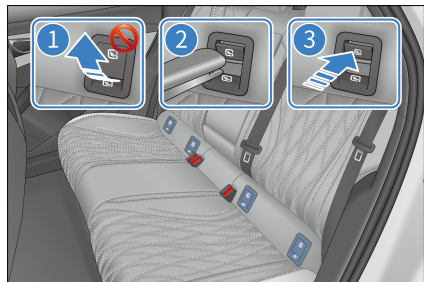

Installing child restraint systems:

1. Open the anchorage lever trim cover and install the child restraint system to the seat.



! REMINDER

- The anchorage lever is located on the bevel at the rear end of the seat cushion. It is visible when the lower part of the child seat trim cover is pressed. After the child seat is removed, the upper part of its cover needs to be pressed to return the cover.

! WARNING

- When using the lower anchoring device, make sure that no foreign objects are around the anchoring device and that the seat belt is not stuck behind the child seat; make sure that the CRS is securely fixed. Otherwise emergency parking or an accident may result in serious injury to the child or even death.

2. Open the anchor support cover.

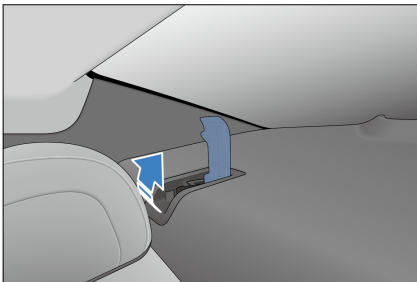

3. Fasten the snap hook to the anchor support and tighten the top tether to ensure the strap is buckled securely.

- ① Top tether
- ② Anchor support
- ③ Snap hook

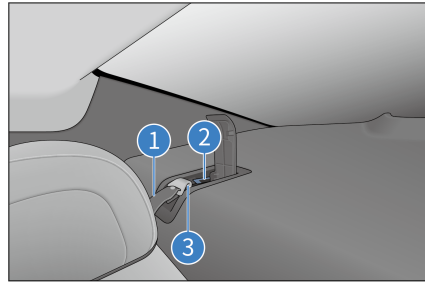
**! REMINDER**

- If the CRS is equipped with a top tether, secure the tether to the anchoring device.

! CAUTION

- Push/Pull the child seat in different directions to ensure it is securely installed.

- If the driver seat obstructs the correct installation of the CRS, install it on the left rear seat.

Always follow the instructions below when using a child restraint on a rear seat:

- When installing the child restraint system on the rear outboard seats, if there is no front passenger, the front passenger seat can be adjusted to make sure there is enough space for the rear child seat.
- The head support can be adjusted or even removed to ensure that the vehicle seatback can safely support the child restraint system.
- When a child restraint is without seatback, never remove the head support from the vehicle and adjust it to locking position.

- When the top tether is used on a second-row outboard seat, route it at the outside of each head post.
- For more installation instructions, please read the instructions provided with your child restraint system.

Details on child restraint system installation:

- ① Driver seat
- ② Front passenger seat
- ③ Rear left seat
- ④ Rear center seat

⑤ Rear right seat

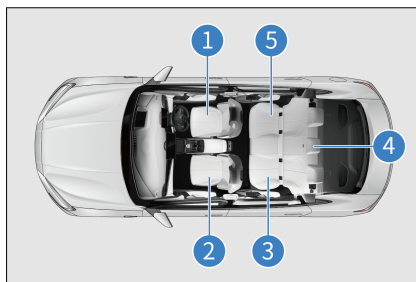

Seat belt, ISOFIX or i-Size CRS installing options in the vehicle:

	Seating Position					
	1	2		3 ^{b)}	4 ^{b)}	5 ^{b)}
		Front Passenger Airbag Activated ^{a)}	Front Passenger Airbag Deactivate ^{d)}			
Seating position suitable for universal belted (Yes/No)	×	x	x	Yes	Yes	Yes
i-Size seating position (Yes/No)	×	x	x	Yes	No	Yes
Seating position suitable for lateral fixture (L1/L2/No)	×	x	x	No	No	No
Largest suitable rearward-	×	x	x	R1/R2X/R2/R3	No	R1/R2X/R2/R3

Seating Position

	2					
1	Front Passenger Airbag Activated a)	Front Passenger Airbag Deactivate d a)	3 b)	4 b)	5 b)	

facing fixture
(R1/R2X/R2/R3/No)

Largest suitable forward-facing fixture (F2X/F2/F3/No)	×	x	x	F2X/F2/F3	No	F2X/F2/F3
---	---	---	---	-----------	----	-----------

Largest suitable booster fixture (B2/B3/No)	×	x	x	B2/B3	No	B2/B3
--	---	---	---	-------	----	-------

a) If needed, the seat can be adjusted in forward or backward, and the seatback angle can be adjusted.

b) If needed, the headrest can be adjusted or even removed. The front seats can be adjusted to ensure the child is not in contact with them.

×: seat position not suitable for installing a child restraint of this weight group

Recommended child restraint system (CRS)

• Recommended child restraint systems:
(Grouping of child stature according to ECE R129 standard)

Choose a suitable child restraint system for your child's age and stature.

Child Stature (cm)	Manufacturer	Child Restraint System	Comment
40-83 cm	Maxi-Cosi	Pebble 360	Belted
76-105 cm	Britax Römer	Trifix 2 i-Size	ISOFIX and belted

Child Stature (cm)	Manufacturer	Child Restraint System	Comment
100-150 cm	Britax Römer	Kidfix i-Size ^{a)}	ISOFIX and belted

^{a)}: Be sure to attach the seat belt through SecureGuard and XP-PAD.

Grouping of child weight according to ECE R44 standard

Child Weight	Manufacturer	Child Restraint System	Comment
22-36 kg	Graco	Booster Basic	Belted

- ① 40-83 cm
- ② 76-105 cm
- ③ 100-150 cm
- ④ 22-36 kg

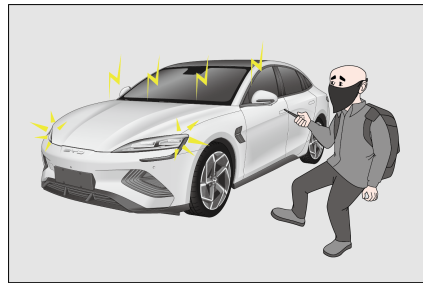

Arming the System

1. Switch the ignition off.
2. All occupants get off the vehicle.
3. Lock all doors. The anti-theft indicator is solid on when all doors are locked. The anti-theft system will be enabled automatically 10 seconds later. When the system is enabled, the anti-theft indicator begins to flash.
4. You can leave the vehicle after confirming that the indicator begins to flash. Since unlocking the door from inside the vehicle will activate the system, never let anyone stay in the vehicle with the system enabled.

Triggering the Alarm

- The system will raise an alarm in any of the following situations:

Anti-theft System

Anti-theft System

If the vehicle is in anti-theft mode, it sounds an alarm and turn signals flash when any door is opened.

- Any door, trunk, or hood is opened without using the keyless access function of the smart key.

Disarming the System

- Anti-theft alarm can be stopped by:
 - Unlocking the door with a valid smart key/NFC key.
 - Using the microswitch to unlock the door by carrying a valid smart key.
 - Opening the trunk remotely with a valid smart key.
 - Starting the vehicle remotely with a valid smart key.
 - Pressing the START/STOP button inside the vehicle while carrying a valid smart key.

WARNING

- Do not modify the anti-theft system by means of alteration or addition. Otherwise, the system may fail.

Anti-theft Indicator

With the vehicle power OFF and four doors locked, the anti-theft indicator will stay on for about 10s after the anti-theft mode is activated.

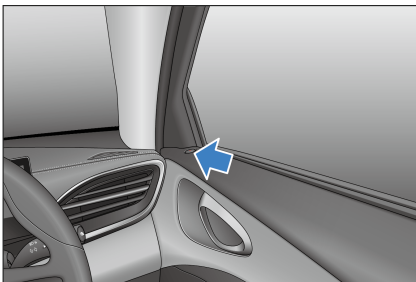

Data Collection and Processing

Data Collection and Processing

- This section provides you with some important information on how personal data is collected and processed when you use a BYD vehicle.
- For a more detailed overview on data processing, data protection and data subject rights, please read the current version of the privacy policy for the vehicle available at the infotainment system (**Vehicle Settings** → **System Settings** → **More** → **Privacy Policy**).
- This vehicle is equipped with an event data recording (EDR) system. EDR mainly records data in the event of a crash or near-crash (for example, airbag deployment or hitting on a roadside obstacle) to help comprehend the vehicle system operation, such as:
 - Vehicle velocity
 - Tire pressure condition
 - Adaptive cruise control (ACC) system status
 - Whether the seat belt is fastened
- The vehicle records EDR data only when there is a crash or when a near-crash event reaches a certain extent. The EDR does not record any data during the normal driving of the vehicle.
- The data recorded by the EDR system provides an understanding of the state of the vehicle's safety-related systems when an accident occurs, so that relevant parties can analyze the accident.

- The EDR data needs to be accessed and read by special equipment. BYD discloses your personal data to third parties only if this is legally permissible or you have consented to it. In addition to the vehicle manufacturer, third-party agencies with professional equipment (such as government agencies) can also read the EDR data if they have access to the vehicle EDR and equipment (for example, they can read the data of SRS control unit to clarify the accident).

Vehicle Data Processing

- Data is collected when the vehicle is used, such as data collected or transmitted by vehicle sensors or control units, which is necessary for the safe functioning of your vehicle.
- In some cases, the data is used to support driving (driver assistance systems) or to enable a specific comfort or infotainment function.
- Personal data that is collected and processed mainly include in-vehicle data, remote-services-related data, and other data, as further specified below.

In-vehicle data

Operation data

- When the vehicle is used, various vehicle status data (e.g., speed, battery level, and braking system) or environment (e.g., distance sensors and temperature) data is collected and processed.
- This data is not usually stored, but there are control units, sensors or other components installed in the vehicle that record such data, for example, to record maintenance requirements, error messages, or other information.

- The in-vehicle data will only be stored in the equipment in the vehicle but can be read out via the legally required OBD ("On Board Diagnostics") interface, for example, by BYD authorized dealer or service provider or other third parties.
- In case this access takes place during vehicle maintenance, the information can also be transmitted to BYD engineers for quality assurance, product defect reports, or customer claim verification.

Remote-services-related data

Remote monitoring services

- The vehicle has remote monitoring services.
- These include remote monitoring services such as remote diagnosis and over-the-air (OTA) updates and upgrades for security and safety purposes (subject to owner's approval).
- These monitoring services serve the following purposes: service provision (remote support/diagnostics), product development, and security/public safety.
- Depending on the country and setup, various vehicle information can be transmitted to BYD's data center in corresponding market for the above purposes, including vehicle location information, vehicle status, such as energy consumption, vehicle speed, gear position, power mode, ESC status, steering system status, battery status, powertrain status, and overall vehicle performance status.

Other

Infotainment system

- Depending on vehicle configuration, data can be added to the infotainment system by the users themselves, such

as media data for playing video on the infotainment system, address data for use in the navigation system, or data for use in online services.

- Depending on vehicle configuration, individual settings in and on the vehicle can also be entered.
- Data stored in the vehicle can be deleted at any time.
- BYD has no control over data transferred to third parties (from the use of third party content, in particular as part of online services).

Integration of mobile devices

- Depending on vehicle configurations, the Internet can be accessed for certain functions or BYD services through the vehicle's infotainment system network devices.
- It may be necessary that the device's screen or audio is displayed/played through the infotainment system or transmitted to it.
- Additional data like positioning or vehicle information can be transmitted through applications for use in certain navigation systems, communication, or other third-party services.
- The specific type of data processing depends on the respective function and is controlled by the user or third parties such as the provider of the devices or corresponding services.

Internet access and connected services



- Depending on vehicle configurations, the Internet can be accessed for certain functions or BYD services through the vehicle's infotainment system network devices.
- BYD is not liable for any such services provided by any other party.
- In such cases, please obtain information about the use of data from

the provider of the respective online service.

Camera image recording/surrounding area monitoring

- Your vehicle is equipped with a number of cameras/sensors.
- The reason for this is that some vehicle functionalities require the vehicle's path to be detected and assessed which is done by cameras that detect objects in the vehicle's surroundings (e.g., obstacles).
- The images are transmitted to the respective control module for further analytics required to operate the systems.
- Some images are just processed on a volatile basis (RAM), others may be stored, depending on vehicle equipment.
- The vehicle may be equipped with an outward-facing camera (OFC) that can be used to take footage of the surrounding (for example, dashcam).
- The vehicle may also be equipped with an inward-facing camera (IFC), which can be used to take footage inside the vehicle.
- Both OFC and IFC footage will be stored.
- You are responsible to check the laws of your residence if you turn the camera on.
- Please be aware of corresponding laws before turning on your OFC or IFC (for instance, in some countries consent is required for the use of IFC, and in others OFC is strictly restricted to dashcam purposes).
- For more camera details, see section "Panoramic View System" in this manual.

Permanent Vehicle Transfer to Third Parties and Offline Mode

- In case of a permanent vehicle transfer, i.e., second hand vehicle, or vehicle transfer by a third party for permanent use, it must be noted that any personalization/user settings made via the infotainment system (e.g. address list, navigation system, etc.) may be accessed by the new owner.
- You can also restrict your vehicle's communication with the BYD data server and the processing of vehicle-related and personal data by setting the vehicle to offline mode.
- On the infotainment touchscreen, tap  to turn Wi-Fi off.
- This can also be done by tapping  → **System Settings** → **Internet** → **WLAN** → **Off**.

Disclosure of Personal Data to Authorities

- BYD discloses your personal data to third parties only if this is legally permissible or you have consented to it.
- However, subject to applicable laws, government agencies may be authorized to read out data from vehicles (e.g. data can be read from the airbag control unit to clarify an accident).
- If required by law, BYD may also be obliged to disclose data upon request to governmental authorities in your country, e.g. in the investigation of a criminal offence.

Your Data Protection Rights

- BYD has staunch respect for its customer's privacy, and strictly

complies with all data protection laws, in particular the General Data Protection Regulation (GDPR) and applicable local laws.

- According to these laws, owners have specific rights when their personal data is processed:
 - Data subjects have the right of information and access, to rectification, erasure of personal data ("right to be forgotten") and the right to object to the processing of personal data or to restrict it (or to withdraw consent given earlier, as well as the right to data portability).
- These rights may be limited in some cases. For example, if we can show that we have a legal obligation to process your data, or if providing the information to you would disclose personal data about another person, or if we are legally prevented from disclosing that information.
- In some cases, this may mean that we can retain the data even if you withdraw your consent.
- For more information on data processing, data protection, and any rights you may have, please visit the latest version of the Privacy Policy available at the infotainment system (**Vehicle Settings** → **System Settings** → **More** → **Privacy Policy**).

02

INSTRUMENT CLUSTER

Instrument Cluster.....34

Instrument Cluster

Instrument Cluster

LCD Instrument Cluster

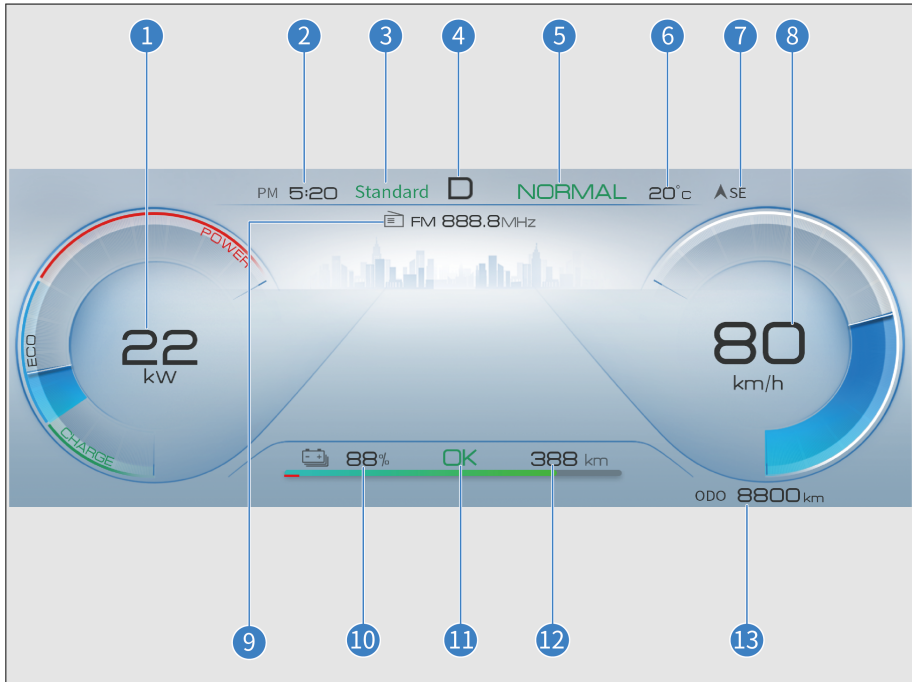

- | | | | |
|---|--------------------------------|----|---|
| 1 | Power meter | 8 | Speedometer |
| 2 | Time | 9 | Media (radio, music and call) |
| 3 | Regenerative braking intensity | 10 | State of charge (SOC) |
| 4 | Gear status | 11 | OK button |
| 5 | Dynamic mode | 12 | Remaining driving range |
| 6 | Outside temperature | 13 | Total mileage (Mileage 1 and Mileage 2) |
| 7 | Direction | | |

CAUTION

- For BYD SEAL, the instrument cluster is available in two themes, namely, classic and minimalist styles. Each theme has “Dark” and “Light” modes dedicated for day and nighttime respectively.

Instrument cluster view in simple mode

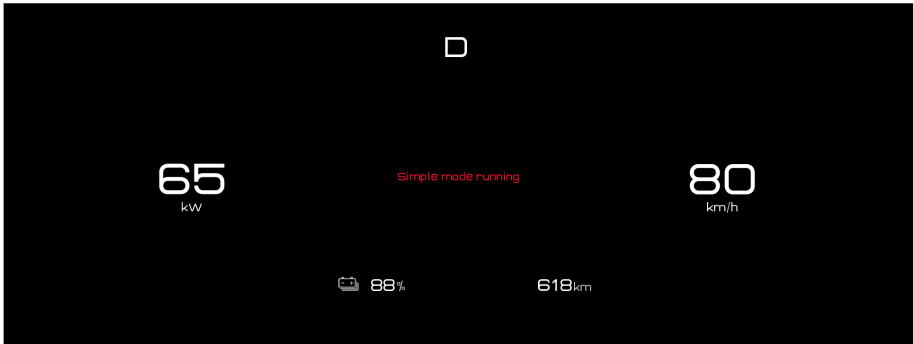

CAUTION

























- During occasional communication delays in the instrument cluster system, the instrument cluster may automatically switch to simple mode for safe driving. In this mode, the instrument cluster continues to display driving related information normally without affecting normal vehicle travel. After the system becomes normal, the instrument cluster may automatically exit the simple mode. If it does not, try the following actions to switch back to normal mode:
 1. Press and hold the scroll button on auxiliary dashboard for three seconds to restart the instrument cluster information display system.

























CAUTION

2. While vehicle safety is ensured, operate the vehicle power switch to turn off the vehicle and then turn the ignition on.
- If the instrument cluster remains in simple mode after those actions have been taken, promptly contact a BYD authorized dealer or service provider for inspection.
 - The image of the instrument cluster view is for reference only and is subject to actual factory configuration.

Instrument Cluster Indicators

Indicators and Warning Lights

	Turn signal indicator		Position light indicator
	High beam indicator		HMA indicator*
	OK indicator		Discharge indicator
	ICC indicator		Hill descend control indicator
	AVH indicator		Light switch indicator
	Economic mode indicator		Sport mode indicator
	Normal mode indicator		AEB indicator
	ACC speed indicator		ACC fault warning light
	Snow mode indicator		AVAS OFF indicator
	High-voltage battery low SOC warning light		AEB warning light
	Driver attention warning light*		Rear fog light indicator
	Tire pressure fault warning light		Smart key warning light

	ESC OFF warning light		Main alarm indicator
	ESC fault warning light		Headlight fault warning light
	ABS fault warning light		Driving power limit warning light
	BSD indicator*		Reversing radar fault prompt
	CPD indicator/warning light*		Steering system fault warning light
	PCW warning light (red)		High-voltage battery overheating warning light
	Motor overheating warning light		Motor coolant overheating indicator
	Powertrain fault warning light		Parking system fault warning light
	Seat belt reminder indicator		Airbag fault warning light
	EPB indicator		Low-voltage power system fault warning light
	TSR indicator		High-voltage battery fault warning light
	High-voltage battery charging connection indicator		Zero position indicator

Warning Lights/Indicators Description



Smart key warning light

- If the key is not in the vehicle when you press the START/STOP button, this warning light comes on for a few seconds, a beep sounds, and the message "No key detected, please

confirm if the key is in the vehicle" is displayed on the instrument cluster.

- If you press the START/STOP button while an electronic smart key matching the model is in the vehicle, this warning light does not light up. The vehicle can now be powered on.
- If the warning light flashes after you press the START/STOP button, it indicates low battery of the key.
- If the key is not in the vehicle, the instrument cluster prompts "No key detected, please confirm if the key is in the vehicle".



ABS fault warning light

- This warning light comes on when the ignition is on. If the anti-lock braking system (ABS) is working properly, the light goes out in a few seconds. Thereafter, if the system fails, the light lights up again until the fault is cleared.
- When the ABS fault warning light is on (with the parking system fault warning light off), the braking system continues to operate whereas the ABS does not.
- When the ABS fault warning light is on (with the parking system fault warning light off), since the anti-lock braking system does not operate, the wheels will be locked in case of emergency braking or braking on a slippery road.
- If any of the following cases occurs, it means there is a fault in components monitored by the warning light system. In that case, contact a BYD authorized dealer or service provider for vehicle inspection as soon as possible.
 - This warning light does not come on or is steady on when the ignition is on.
 - This warning light turns on during driving.



REMINDER

- A warning light that lights up briefly during operation does not indicate a problem.
- If the ABS fault warning light is still on while the braking system warning light is on, immediately park the vehicle in a safe place. It is recommended to contact a BYD authorized dealer or service provider. In this case, if brakes are applied, the ABS will not work and the vehicle will become extremely unstable.

- If both the ABS indicator and braking system warning lights go on after the electronic parking brake (EPB) is released, it indicates that the electronic brake-force distribution (EBD) system of the front and rear tires has also failed.



Tire pressure fault warning light

- This warning light comes on when the ignition is on. It turns off in a few seconds if the tire pressure monitoring system is working properly. If the system fails, this warning light turns on again.
- When the tire pressure fault warning light comes on or flashes, the message "Please check TPMS" is displayed on the instrument cluster, and the tire pressure is displayed as "---", it indicates that the tire pressure system is faulty.
- When the tire pressure value displays "No Signal", it indicates that the tire pressure signal at this location may be interfered or the tire pressure monitoring module is damaged.
- When the tire pressure fault warning light flashes rapidly and one or more

values turn red on the tire pressure screen on the instrument cluster, the corresponding tire is leaking rapidly.

- When the tire pressure fault warning light is solid on and one or more values turn yellow on the tire pressure screen on the instrument cluster, the corresponding tire is in under-pressure condition. When the temperature value of one or more tires turns yellow, it indicates that the tire temperature is too high.

In the event of any of the situations above, it is recommended to contact a BYD authorized dealer or service provider for inspection as soon as possible.



ESC fault warning light

- This warning light comes on when the ignition is on. If electronic stability controller (ESC) functions properly, the light goes out in a few seconds. If the system fails, this warning light turns on again until the system fault is cleared.
- If the ESC warning light flashes temporarily while the vehicle is in motion, it indicates the ESC system is working.
- When the ESC warning light turns on (with the ABS fault warning light and the parking system fault warning light off), the ESC fails, but the ABS and the braking system continue to operate normally.
- When the ESC warning light turns on (with the ABS fault warning light and the parking system fault warning light off), the ESC system does not work. This means the vehicle is extremely unstable at sharp turns or when the driver steers away from obstacles ahead.
- If any of the following cases occurs, it means there is a fault in components

monitored by the warning light system. In that case, contact a BYD authorized dealer or service provider for vehicle inspection as soon as possible.

- This warning light remains off (self-check not performed) after the vehicle is powered on.
- This warning light is steady on while driving.

REMINDER

- A warning light that lights up briefly during operation does not indicate a problem.
- If the ESC warning light remains on while the warning lights for the ABS and the braking system are on, immediately stop the vehicle in a safe place and contact a BYD authorized dealer or service provider. This is because braking at this time can render the vehicle extremely unstable, and the anti-lock braking system does not work at all.



ESC OFF warning light

- When the ESC OFF switch is pressed, this warning light should remain steady on and the ESC system will not operate. When the ESC OFF switch is pressed again, this warning light should turn off and the ESC system resumes its normal operation.

REMINDER

- While the ESC OFF warning light is on, the driver must stay alert and keep driving at a lower speed when making a sharp turn and when avoiding an obstacle which appears suddenly, because

REMINDER

braking at this time can render the vehicle unstable, given the malfunction of ESC system.



Driving power limit warning light

- When the power of the vehicle is limited, this indicator will come on. In this case, contact a BYD authorized dealer or service provider in time.



Headlight fault warning light

- When the warning light is yellow, it indicates the headlight is faulty, and it is recommended to bring the vehicle to a BYD authorized dealer or service provider for inspection.



Blind spot detection (BSD) indicator

- When this indicator is on, it is recommended to bring the vehicle to a BYD authorized dealer or service provider for inspection.



Main alarm indicator

- If this indicator goes on, check the fault prompt or warning on the instrument cluster.



Driver attention warning (DAW) light

- Driver attention warning (DAW) system evaluates the driver's degree of fatigue by the vehicle operation status. The driver would be reminded according to the evaluation results to ensure driving safety.



CPD indicator/warning light*

- CPD indicator*: If child presence detection (CPD) is turned off, the indicator is solid on, and the OFF reminder lasts for five seconds. Tap ON or Delay. The indicator turns off and CPD is enabled.
- CPD warning light*: If the CPD fault reminder lasts for five seconds and the indicator is solid on, it indicates that the CPD system fails. It is recommended to bring the vehicle to a BYD authorized dealer or service provider for inspection.



Seat belt reminder indicator

- With the ignition switched on, if any passenger on the front seats or rear seats* has not buckled up, the seat belt reminder indicator lights up. It remains on until the seat belt is fastened.



Airbag fault warning light

- With the ignition switched on, this warning light turns on and then goes off in a few seconds if the airbag system is working properly. This warning light is used to monitor the airbag ECU, collision sensors, inflation device, warning lights, connections, and power supply.
- If any of the following cases occurs, it means there is a fault in components monitored by the warning light system. In that case, contact a BYD authorized dealer or service provider for vehicle inspection as soon as possible.
 - When the ignition is switched on, this warning light remains off or is solid on after the ignition is switched on.

- This warning light turns on during driving.



Parking system fault warning light

- When the brake fluid level is low and the braking system is faulty, this warning light lights up. If any of the following conditions occurs, immediately park the vehicle in a safe place. It is recommended to contact a BYD authorized dealer or service provider.
 - This warning light comes on when the ignition is switched on and the brake fluid level is low.



REMINDER

- When the brake fluid level is low, park the vehicle because it is dangerous to continue driving.
- This warning light is solid on although after starting the vehicle, the brake fluid level and EPB system operation are normal (the EPB switch is pulled up and released normally, and the message "Please check the EPB" is not displayed).
- Fault warning lights for parking brake and ABS come on simultaneously.



REMINDER

- A warning light that lights up briefly during operation does not indicate a problem.



Steering system fault warning light

- When the steering system is faulty, this warning light is steady on. It is recommended to bring the vehicle to a BYD authorized dealer or service provider for inspection.



REMINDER

- The steering system features an electric motor to reduce the force required to turn the steering wheel.
- When turning the steering wheel, a hum may be heard from the running motor. This does not indicate that the motor is faulty.
- Do not turn the steering wheel to its limit position for more than five seconds, otherwise the temperature protection will be activated and the steering system will be damaged or steering will become heavy.
- If you have turned the steering wheel frequently with the vehicle staying put for a long time, the steering wheel may become difficult to turn even if the warning light does not turn on. This is not a fault.
- To prevent steering system overheating, the power assist effect will be reduced if the steering wheel has been frequently turned with the vehicle staying put for a long time. As a result, the steering wheel become difficult to turn. In this case, reduce steering frequency or power off the vehicle. The system will recover within 10 minutes.



WARNING

- If the steering system warning light goes on, immediately park the vehicle safely, and contact a BYD authorized dealer or service provider.



Zero position indicator light

- If the vehicle loses power due to abnormal operations such as connecting/disconnecting low-voltage batteries or fuses, when the power supply of the vehicle is restored, the zero position indicator light on the instrument cluster lights up.
- In this case, it is necessary to perform zero self-learning operation of the steering wheel angle, namely: Turn the steering wheel slowly and fully to the left and right respectively, and release it after 2-5s. Then shut down the engine and wait for over 10s. Restart the vehicle, the indicator light disappears, the learning is over.



Low-voltage power system fault warning light

- If this warning light turns on while driving, it indicates that there is a problem with the DC system or the low-voltage power system. Turn off devices such as the A/C, fan, and radio, and pull over the vehicle immediately if it is safe to do so. It is recommended to contact a BYD authorized dealer or service provider for rescue as soon as possible.



Powertrain fault warning light

- If the powertrain fails, this warning light lights up.
- If any of the following cases occurs, it means there is a fault in components monitored by the warning light system. In that case, contact a BYD authorized dealer or service provider for vehicle inspection as soon as possible.
 - This warning light is steady on when the ignition is switched on.
 - This warning light turns on during driving.



CAUTION

- Try not to drive the vehicle when the warning light is on. Contact a BYD authorized dealer or service provider to check the problem as soon as possible.



High-voltage battery overheating warning light

- If this indicator is on, it indicates that the high-voltage battery temperature is too high and the vehicle must be stopped to cool down. When the warning light flashes, it is recommended to immediately stop the vehicle safely and leave the vehicle as soon as possible.
- The high-voltage battery may overheat under the following operating conditions:
 - Driving up a slope for a long time in hot weather.
 - Long period of stop-and-go traffic condition, frequent rapid acceleration, frequent hard braking, or vehicle running for a long time without pause.



High-voltage battery fault warning light

- This warning light comes on when the ignition has just been switched on. If the high-voltage battery system is working properly, this warning light will turn off in a few seconds. Thereafter, if the system fails, this light will light up again. It is recommended to contact a BYD authorized dealer or service provider for inspection as soon as possible.
- If any of the following cases occurs, it means that there are faults in the components monitored by the

warning light system. In such case, it is recommended to contact a BYD authorized dealer or service provider for vehicle inspection as soon as possible.

- This warning light is steady on when the ignition is on.
- This warning light is steady on or occasionally turns on while driving.



PCW warning light (red)

- When this indicator is on or flashes, pay attention to the distance from the vehicle ahead, and do not get too close to it to prevent potential collision.



Motor coolant overheating

indicator

- If this indicator is solid on, it indicates that the motor coolant temperature is too high. Park the vehicle in a safe area until this indicator goes out.





120 TSR indicator*

- When this indicator lights up, it means that the vehicle system has recognized the speed limit value on current road section.

Other Instrument Cluster Fault Prompts

The instrument cluster may display the following fault prompts. Handle them as recommended.

Symbol	Fault Prompt	Response
	Please check the OBC system	The on-board charging system is faulty. In this case, check the charging connection, and reconnect the charging equipment. If the fault persists, contact a BYD authorized dealer or service provider.
	Stop using remote driving for your safety.	Stop using remote driving when it is abnormal.
	Please check the vehicle data network.	The vehicle may be disconnected from the data network. In this case, park the vehicle immediately, and contact a BYD authorized dealer or service provider.
	Please check the memory system*	The memory system is faulty. In this case, contact a BYD authorized dealer or service provider.
	EV power limited	The EV function is limited. Contact a BYD authorized dealer or service provider immediately.
	Please check the headlight	The headlight is faulty. In this case, contact a BYD authorized dealer or service provider.

	Please check the PCW system.*	The PCW system is faulty. In this case, park the vehicle, and contact a BYD authorized dealer or service provider.
	The AEB function is limited.*	The AEB system is faulty. In this case, park the vehicle, and contact a BYD authorized dealer or service provider.
	Please check the BSD system.*	The blind spot detection system for lane change is faulty. In this case, park the vehicle, and contact a BYD authorized dealer or service provider.
	The BSD function is limited.*	The BSD function is limited. In this case, park the vehicle, and contact a BYD authorized dealer or service provider.
	Please check the gear*	The shifter controller is faulty. In this case, park the vehicle immediately, and contact a BYD authorized dealer or service provider.
	Please check the multi-purpose camera.*	The multi-purpose camera is faulty. In this case, park the vehicle, and contact a BYD authorized dealer or service provider.
	The function of the multi-purpose camera is limited.*	The function of the multi-purpose camera is limited. In this case, park the vehicle, and contact a BYD authorized dealer or service provider.
	Intelligent-camera is not available due to poor condition*	The smart camera is not operational. In this case, park the vehicle, and contact a BYD authorized dealer or service provider.
	Please check the lane departure warning system (LDWS)*	The LDW system is faulty. In this case, park the vehicle, and contact a BYD authorized dealer or service provider.
	Please check the LKS.*	The lane keep system (LKS) is faulty. In this case, park the vehicle, and contact a BYD authorized dealer or service provider.
	The LKS function is limited.*	The LKS function is limited. In this case, park the vehicle, and contact a BYD authorized dealer or service provider.

03

CONTROLLER OPERATION

Doors and Keys.....	46
Seats.....	58
Steering Wheel.....	62
Switches.....	65

Doors and Keys

Keys

The vehicle is equipped with keys, including the electronic smart key, mechanical key (installed in the electronic smart key) and NFC key card* to enable functions such as unlocking/locking doors and starting the vehicles.



Electronic Smart Key

Lock or unlock all doors by pressing the front door microswitch while carrying the electronic smart key. Buttons on the key help you lock or unlock doors, open the trunk, and start the vehicle remotely.

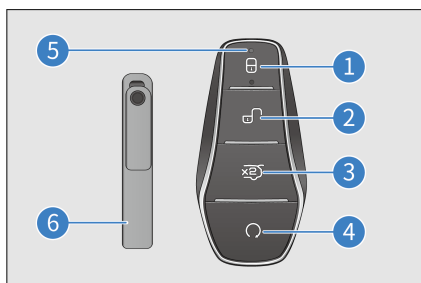
- ① Lock button
- ② Unlock button
- ③ Trunk release button
- ④ Start/Stop button
- ⑤ Indicator
- ⑥ Mechanical key



WARNING

  Button battery safety alert:

- The button (coin) battery in the smart key is hazardous and both

WARNING

new and used batteries are to be kept away from children at all times.

- If swallowed or placed inside any part of the body, a lithium button battery can cause severe or fatal injuries in two hours or less.
- Medical attention should be sought immediately if it is suspected the button battery has been swallowed or placed inside any part of the body.

CAUTION

- The electronic smart key is an electronic component. The following instructions should be observed to prevent damage to the electronic smart key.
 - Do not place the smart key in a position exposed to high temperature, such as on the dashboard.
 - Do not tamper with the smart key.
 - Do not hit other objects with the smart key or drop it.
 - Do not immerse the key in water or clean it in the ultrasonic scrubber.
 - Do not place smart keys with devices that emit electromagnetic waves, such as the mobile phone.
 - Do not attach any objects (such as a metal seal) which cut off electromagnetic wave signals when using the card.
- You can register a spare key for the same vehicle. In this case,

**CAUTION**

contact a BYD authorized dealer or service provider immediately.

- If the electronic smart key cannot operate the door within the normal distance, or the key indicator light is dim or off:
 - Check for nearby radio stations or airport radio transmitters that interfere with the normal operation of electronic smart keys.
 - The battery of an electronic smart key may be exhausted. Check the battery inside the electronic smart key. It is recommended to contact a BYD authorized dealer or service provider for inspection as soon as possible.
- If you lose your smart key, it is recommended to contact a BYD authorized dealer or service provider as soon as possible to reduce the risk of vehicle theft or accidents.
- Do not change the transmission frequency arbitrarily, increase the transmission power (including additional transmission frequency amplifier), or arbitrarily connect the external detection antenna or switch other transmitting detection antennas.
- Do not cause harmful interference to legitimate radio communication services when used; once there is interference, stop using and mining immediately.
- The use of micropower radio equipment must be free from interference of all radio services or from radiation of equipments for

**CAUTION**

industrial, scientific and medical applications.

- When leaving the vehicle, always carry your key and lock the vehicle. Never leave people (especially children) alone in the vehicle.
- People implanted with pacemakers or defibrillators should stay away from the detection antennas of intelligent entry and start systems, as electromagnetic waves can affect the normal use of such devices. In addition to people implanted with pacemakers or defibrillators, those who use other electronic medical devices should also consult the manufacturer on the use of such devices under the influence of electromagnetic waves. Electromagnetic waves may bring unknown consequences to the use of such medical devices.

Mechanical Key

Use the mechanical key (inside the smart key) to lock or unlock the driver's door. When the key is not used, be sure to insert the mechanical key back into the smart key.

Taking out the mechanical key

When using the mechanical key in the electronic smart key, slide the lock-up button in the direction of arrow① and push the back cover of the electronic smart key in the direction of arrow②, hook the head hole of the mechanical key with the projection parts at both ends of the back cover of smart key and pull it in the direction of arrow③ to take out the mechanical key, as shown in the figure.

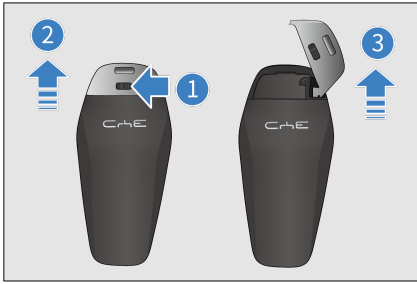

- After using the mechanical key, insert it in the opposite direction and close the back cover of the smart key.

NFC Card*

- Place the NFC key card at the mark on the driver's side mirror to unlock/lock all the doors when the vehicle is powered off.

! CAUTION

- NFC key card is an electronic product. The following instructions must be observed to prevent function failure of or damage to the card:
 - Do not place the card with the phone in the wireless charging area.
 - Do not attach any objects (such as a metal seal, and metal phone back shell) which cut off electromagnetic wave signals when using the card.
 - Do not place the NFC card in a position exposed to high temperature, such as on the dashboard.
 - Do not bend the card with force.
 - Do not place the card with other hard objects.
- NFC key cards use near-field communication technology,

! CAUTION

requiring complete fitting to the target, so it is necessary to place the card in the right position.

- The identification distance of the card is 1-2 cm.
- It may be necessary to make the card in contact with the designated area of the side mirror for successful identification.
- It may cost 1-2s to identify.
- The NFC smart card is a key configured for the vehicle based on the near field communication method. In order to ensure vehicle safety, handle it with care. If it is lost, going to BYD authorized dealer or service provider for blocking of the lost card and re-configuration is recommended.

Locking/Unlocking Doors

Locking/Unlocking with Mechanical Key

1. Push the left side of a hidden door handle, and turn the right side to get a finger height, holding it by a hand.

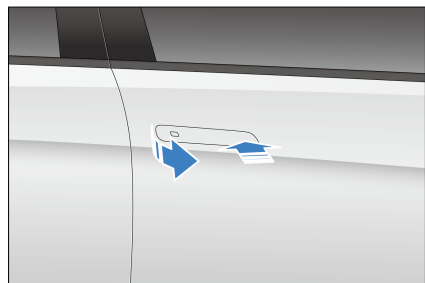

2. Once the right side is extended, pull the middle of the handle outward to extend the handle.

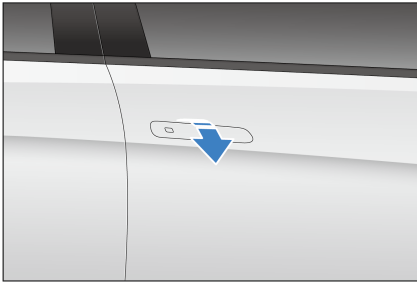

3. Insert the mechanical key into the hole and turn the key.

- Lock the driver's side door by turning the key counterclockwise.
- Lock the driver's side door by turning the key counterclockwise.

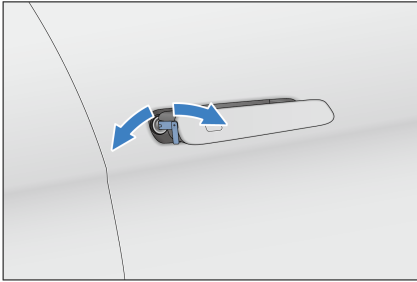

CAUTION

- After pulling out the mechanical key, pull the driver's door handle to open the door.

Opening with Interior Door Handle

- When the vehicle is unlocked, pull the handle once to open the door from inside the vehicle.
- When the vehicle is locked, pull the handle twice to open the door from inside the vehicle.

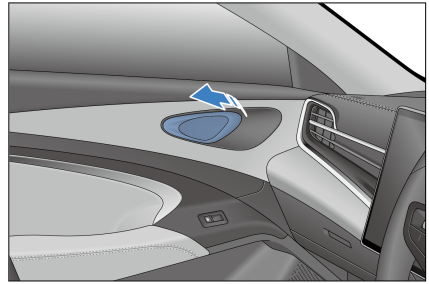

WARNING

- Don't let children play with the pull handle in case the door being accidentally opened when driving then cause accidents.
- When a child is in the vehicle, make sure to enable the child protection lock function.

CAUTION

- Due to the child protection lock function, the rear doors can only be opened when the child protection lock is unlocked, or it cannot be opened from inside the vehicle.

Locking/Unlocking with Smart Key

- The wireless remote control is used to unlock or lock all doors at a close distance, and complete additional functions.
- When you enter the active area while carrying a registered smart key, press the button on the smart key slowly and firmly to lock or unlock all doors.

Locking:

- When the ignition is switched off and all the doors and the hood are closed, press the lock button. All doors then lock. The hidden door handles automatically retract. At this time, the

side mirrors fold in (when the switch is set to AUTO), and the turn signal flashes once. If the vehicle is still on, the side mirrors will not fold, the turn signals will not flash, and the alarm will sound once. Check whether all doors are securely locked.



- If any door is not closed properly, the side mirrors will not fold, the turn signals will not flash, the four door handles will not retract, and the alarm will sound once.
- If the hood or trunk is not closed, the side mirrors will not fold, the turn signals will not flash, and the alarm will sound once.

Unlocking:

- Press the unlock button. All doors are unlocked, the hidden door handles automatically extend, and the turn signal flashes twice.
- When all doors are unlocked with a smart key, the interior light (with the door light switch turned on in the infotainment system) will light up for 15 seconds and then go out, even if the doors are not opened.
- After unlocking the vehicle in anti-theft mode with a smart key, open any door within 30 seconds. Otherwise, all doors will automatically be locked and the four door handles will retract*.

Finding the Vehicle

- When the vehicle is in anti-theft mode, press the lock button. The vehicle sounds a long beep and turn signals flashes 15 times. Use this function to locate the vehicle when it cannot be found.
- When the vehicle is in car search mode, press the lock button again. The vehicle enters the next car search mode.

Raising/Lowering Windows with Smart Key*

- When the ignition is switched off:
 - Press and hold the lock button on the smart key to raise the four windows.
 - Press and hold the unlock button on the smart key to lower the four windows.

To enable or disable key unlock/lock/closing window functions, go to Infotainment touchscreen → Vehicle settings → Window and Lock.



CAUTION

- Before activating the remote window closing, please confirm that any body part of passengers in the vehicle will not be stuck or clamped by the window.

Locking/Unlocking with Microswitch

Locking

- With the doors closed but not locked, press the microswitch on the front door handle while carrying the smart key, then all doors lock at the same time. The hidden door handles fold automatically. If the vehicle is shut down, the side mirrors will fold (when

the Auto-Fold is enabled) with turn signals flashing once. If the ignition has not been switched off, the side mirrors will not fold, the turn signals will not flash, and the alarm will sound once.

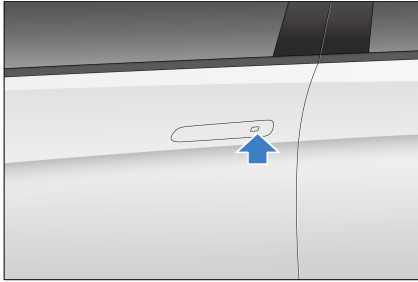

- If any door is not closed, the side mirrors do not fold, the turn signals do not flash, the door handles do not fold and the alarm sounds once.
- If the hood or trunk is not closed, the side mirrors do not fold, the turn signals do not flash, and the alarm sounds once.

Unlocking

- When the vehicle is locked, press the microswitch on the front door handle while carrying the smart key. All doors unlock at the same time. The hidden door handle extends automatically and the turn signal flashes twice.
- If the anti-theft alarm system is armed, open a door within 30 seconds after the unlocking, or all doors will relock automatically and the four door handles retract*.
- Pressing the microswitch does not work if:
 - This is performed while a door is being opened or closed.
 - The key is left in the vehicle.

! REMINDER

- If the electronic smart key is too close to an exterior door handle or window, it may not be possible to activate the entry function.

Raising/Lowering Windows with Microswitch

- When the ignition is switched off, press and hold the microswitch while carrying the smart key to roll up or down all windows (By default, lifting the window function is activated and lowering the window function is closed).
- To enable or disable microswitch lifting/lowering window function, go to infotainment touchscreen → Vehicle Settings → Window and Lock.

Locking/Unlocking the Trunk

Opening the trunk with smart key

Double-press the trunk release button on the smart key. The turn signals then flash twice.

- Anti-forget key
 - If the key is placed in the vehicle or in the trunk with the vehicle locked, when you close the trunk, the vehicle automatically unlocks and the turn signals flash twice.



Unlocking the trunk with microswitch

- With the vehicle locked, press the rear microswitch while carrying a valid key to unlock the trunk.
- With the vehicle unlocked, press the rear microswitch to open the trunk.

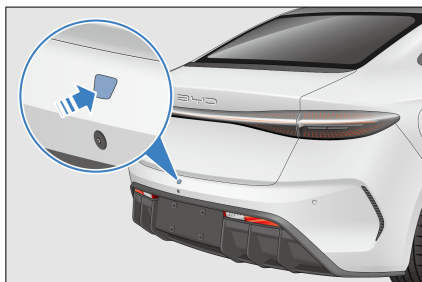

Opening the trunk from inside

With the vehicle unlocked, pull up the electrical trunk lid button.

- If the vehicle speed is greater than 3 km/h, the trunk lid cannot be opened by pulling up the button.

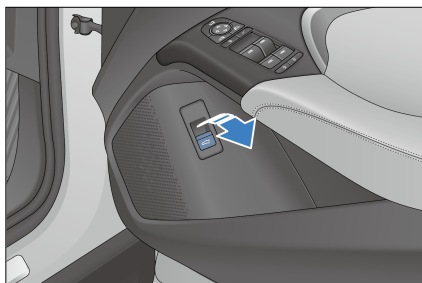

① Trunk lid close button*

- When the trunk lid is open and stationary, press the trunk close button to close this lid.
- Press the trunk close switch again to stop the lid at the current position. If the button is then pressed again, this lid will move in the opposite direction.

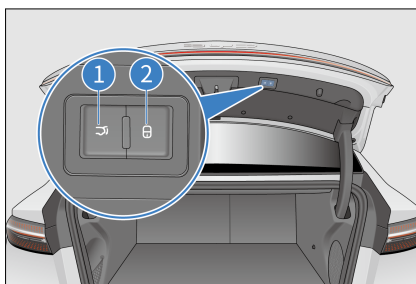

② Vehicle lock button*

- With the vehicle power switched off, press the lock switch while carrying a valid smart key to close the trunk and lock the vehicle, and the vehicle enters anti-theft mode.

! REMINDER

- Before closing the trunk, make sure doors and windows are properly closed to avoid property loss.

Emergency trunk releasing from inside

1. Pull up the folding release clasp on the seat back to fold the rear seat back.



2. There is an emergency unlocking mechanism on the lid cover, open the lid cover in the car by pulling the emergency opening lever on the left (as shown in the figure).

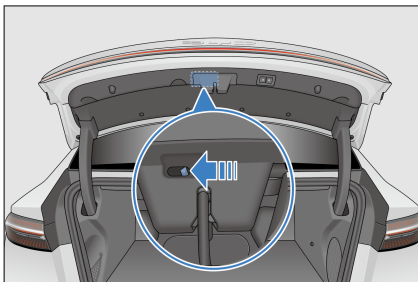

REMINDER

- When the entire vehicle is powered off, the trunk can be unlocked from inside the vehicle.

Setting trunk opening height*

- Open the trunk manually or automatically to the desired position, keep it at this position, and then press and hold the interior trunk button for over three seconds. The speaker sounds for one second, indicating that the opening height is set to the current position.
- Set the trunk opening height by going to the infotainment touchscreen  → Vehicle settings → Window and Lock.

Anti-pinch

If the lid receives a hindering force while it is closing, it will automatically switch to the opposite direction. If it receives a hindering force while it is opening, it will halt.

When the trunk fails to act automatically

Close the trunk manually for recovery.

When reconnecting the low-voltage battery

Close the trunk manually to ensure the power trunk lid functions normally.



WARNING

- In order to prevent serious injury or death, make sure to observe the following precautions when you operate the trunk lid:
 - Never activate the anti-pinch function with your body.
 - If there are people nearby, inform them that the lid is about to open or close for safety.
 - Make sure hands and fingers are clear from the lid area when closing it.
 - When opening or closing the trunk, make sure the surrounding area is safe.
 - Make sure the trunk is closed when driving.
 - Remove any load like ice or snow from the lid before opening the trunk, otherwise the lid may close again.
 - Do not move the lid when it is opening or closing automatically.
 - Be mindful of windy weather when opening or closing the trunk.
 - The anti-pinch function may fail to work if an object is caught right before the trunk is fully closed.
 - The lid may start closing before fully opened. Be mindful of the possibility of the lid to open or close automatically when the vehicle is on the slope. Before loading or unloading the trunk, make sure the lid is fully open and secure.

WARNING

- The anti-pinch function may fail depending on the object shape. Be specially careful not to get your finger or any other object caught.

Locking/Unlocking with NFC Card*

Locking doors

When doors are closed but unlocked, hold the NFC card close to the instruction area on the driver's exterior rearview mirror. All doors can then be locked at the same time. The turn signals will flash once when the vehicle is powered off.

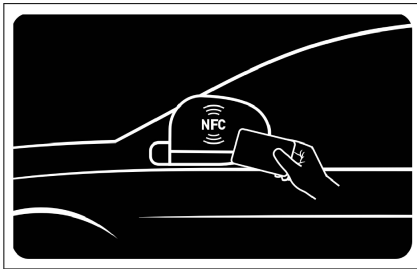

Unlocking doors

When doors are locked, hold the NFC card close to the instruction area on the driver's exterior rearview mirror. Then all doors can be unlocked at the same time. The turn signals will flash twice.

- Doors will not be locked/unlocked when the NFC cards are close to the driver's side mirror:
- The NFC card is placed close to the instruction area on the driver's exterior rearview mirror while doors are being opened or closed.

WARNING

- The keyless start permission lasts for up to 4 min.

REMINDER

- After unlocking the vehicle in anti-theft mode with the NFC key, open any door within 30 seconds. Otherwise, all doors will automatically lock again and all door handles will retract.
- After unlocking by NFC key card, the user can start the vehicle without the key in a stipulated period, while this will be disabled after valid locking.

Locking/Unlocking with Central Locking

Locking or unlocking the vehicle with the central locking

See "Central Locking" in "Driver's Door Switches" in this chapter.

Locking or unlocking doors automatically

- All doors are automatically locked at vehicle speeds above 8 km/h.
- Press the START/STOP button to switch the ignition off. Then, all doors are locked automatically.

Locking and unlocking all doors concurrently

- When the vehicle is not in anti-theft mode, the backlight of the central lock button turns on if the vehicle is locked and turns off if the vehicle is unlocked.
- Pressing the central lock button locks all doors so that any attempt to open any door from the outside fails. At this time, pull the interior door handle to

unlock a door and pull a second time to open it.

! REMINDER

- All doors unlock automatically when the vehicle suffers a strong impact, depending on the impact intensity and accident type.

Emergency Vehicle Locking with Mechanical Key

- When the center console lock fails, lock the driver door with the mechanical key. Use the key to turn the emergency locking knobs of the other three doors counterclockwise to the locked state, and then close the doors. At this time, the entire vehicle has been locked so that doors cannot be opened with any of the four exterior door handles.
- To unlock the doors, unlock the driver door with the mechanical key first, enter the vehicle, then pull other door handles twice to open the doors.

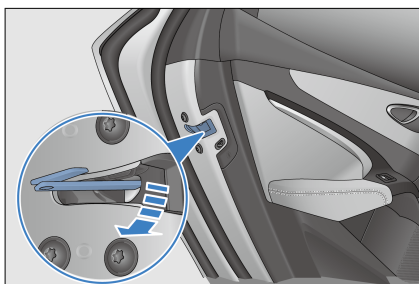

! REMINDER

- Prevent excessive force from distorting or breaking the key during the operation.

Smart Access and Start System

Use the smart key to unlock or lock the vehicle doors and start the vehicle.

Access

Use the smart key to unlock or lock the vehicle doors (See this Chapter "**P49**" and "**P50**").

! REMINDER

- If the electronic smart key is too close to a door handle or window, it may not be possible to activate the entry function.

Start-up

With the smart key inside, press the brake pedal and the START/STOP button to start the vehicle. (See **P102**.)

! CAUTION

- Do not touch the power button while driving.

Antenna Positions

- ① Interior detection antenna
- ② Exterior detection antenna

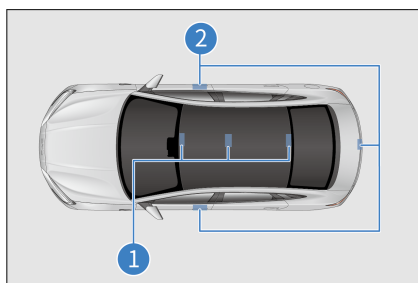

Active Area

The smart access and start functions take effect only when the registered smart key is within the active area.

① Active area of the access function: about 1 meter from the front door handle and the exterior trunk switch.

② Active area of the start function: inside the cabin.

If another smart key is near this vehicle's smart key, unlocking may take longer than usual, which is normal.

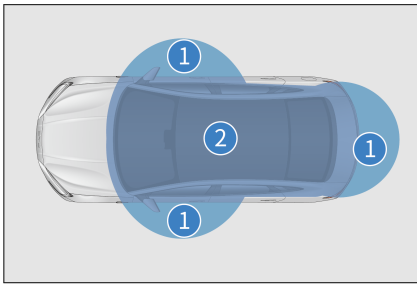

! REMINDER

In the following situation, smart access and start system may not work normally:

- There is a strong electromagnetic field nearby, such as TV towers, power stations, and broadcasting stations.
- The smart key is being carried along with a communication device, such as a two-way radio or mobile phone.
- The smart key is in contact with or covered by a metal object.
- The door handle is operated too quickly.
- Another wireless remote control function is being used nearby.

! REMINDER

- When the smart key battery runs out.
 - The smart key is close to high-voltage equipment or equipment that produces noise.
 - The smart key is being carried along with another smart key or radio-wave-emitting device.
 - Even within the active area, the smart key may not work properly in certain locations, for example, on the dashboard, in the glove box or on the floor.
-
- If the smart access system is not working properly and it is impossible to enter the vehicle, the mechanical key can be used to lock/unlock the driver's door, or the wireless remote control function can be used to lock/unlock all doors.
 - Pressing the START/STOP may not enable the start function due to:
 - If the smart key fails to work, smart key warning light on the instrument cluster lights up and the instrument cluster displays the message "Smart key power is low".
 - If the smart access and start system cannot work properly due to system failures, bring all smart keys to a BYD authorized dealer or service provider for repair.

Saving battery power

- The smart key communicates with the vehicle even when the vehicle is not running. Therefore, do not leave the smart key in the vehicle or within 2 meters from the vehicle.
- Receiving strong electromagnetic waves for a long time drains the battery of the smart key quickly. The

smart key must be kept at least 1 meter away from the following devices:

- TVs
- PCs
- Wireless telephone chargers
- Electroliers
- Fluorescent desk lamps

Child Protection Lock

Configuration 1

Child protection locks are designed to prevent children in rear seats from accidentally opening rear doors. Such locks are provided on the sides of the left and right rear doors.

- ① Deactivating the child protection lock
- ② Activating the child protection lock

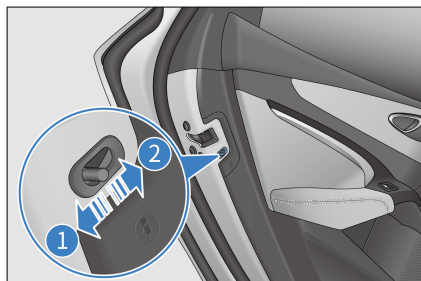

Activating the child protection lock

- Toggle the switch as the arrow ② indicates to activate child protection lock, then the door cannot be opened from inside the vehicle. Use the exterior door handle to open this door.

Deactivating the child protection lock

- Move the latch in the direction of arrow ① to turn off the child protection lock. The door can be opened from inside the vehicle.

Configuration 2

Child protection locks are designed to prevent children in rear seats from accidentally opening rear doors. Such locks are provided on the sides of the right rear door.

- ① Child protection lock for the rear left door
- ② Child protection lock for the rear right door

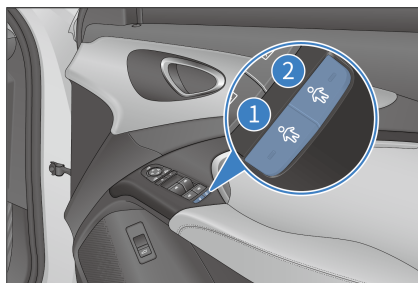

To activate child protection locks, press the child protection lock button ① or ②. The corresponding indicator lights up. At this time, the occupants cannot open the rear door on the corresponding side. To unlock the door, press the child protection lock button for the corresponding side again or use the exterior door handle.

WARNING

- Before driving, especially when a child is in the vehicle, ensure that the doors are closed and the child protection lock function is enabled.
- Proper use of seat belts and activation of child protection lock helps prevent the driver and passengers from being thrown out of the vehicle in an accident, and also prevents a door from being opened accidentally.
- After the child protection lock is locked, doors cannot be

 **WARNING**

opened from inside the car, and the window switch for the corresponding rear door cannot be used to raise or lower the window.

Seats

Seat Precautions

When the vehicle is running, all passengers in the vehicle must keep the seat backs upright, have their backs against the seat backs, and fasten seat belts correctly.

 **WARNING**

- Do not drive the vehicle until occupants are seated properly.
- Sitting on a folded seat back or on cargo is prohibited. Improper seating position or improperly fastened seat belts can result in severe personal injury in case of emergency braking or a collision.
- It is prohibited to stand or move around the seats when driving, or passengers may get injured in case of emergency braking or a collision.

Seats Adjustment Precautions:

Adjust the driver's seat so that the pedals, steering wheel, and dashboard controls are all within the driver's easy control.

 **REMINDER**

- Do not adjust the seat while the vehicle is in motion, as unpredictable seat movement can

 **REMINDER**

cause the loss of vehicle control at this time.

- While adjusting a seat, do not let it hit against any passenger or the luggage.
- After manually adjusting the seat to a proper position in the horizontal direction, slide it forward and backward to confirm that the seat has been locked.
- After adjusting the seat back, lean back to confirm the seat back has been locked.
- Do not place any items under the seats. The driver may lose control of the vehicle because items placed there affect the seat locking mechanism or accidentally push up the seat position adjustment lever, causing the seat to move suddenly.
- When adjusting the seat, do not place your hand under the seat or near its operating parts, to prevent being crushed.

Adjusting Front Seats

Adjusting Front Seat with Power

Power front seat adjustment include seat position and cushion height* adjustment, seat* and seatback angle adjustment. Choose the following methods according to the actual configuration of your vehicle.

① Seat position adjustment switch

- Move the seat position adjustment switch back or forth to slide the seat backward or forward.

- Move the rear end of the switch up or down to raise or lower the seat.
- Move the rear end of the switch up or down to adjust the height of the seat cushion.

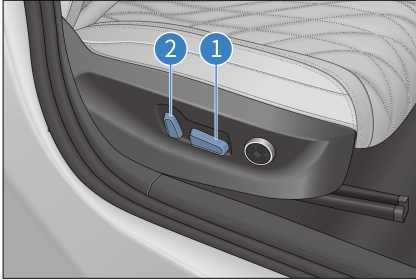

② Seatback angle adjustment switch

- Toggle the the seatback angle adjustment switch front and back to adjust the seat back angle.

! REMINDER

- Releasing the switch stops the seat in this position. Do not place anything under the seat as this may prevent the seat from operating.

Lumbar support adjustment*

The seatback profile can be adjusted to fit the curvature of the occupant's lumbar spine.

- Press the front or rear portion of the switch to increase or decrease the curvature.
- Press the upper or lower portion of the switch to extend the curvature up or down.

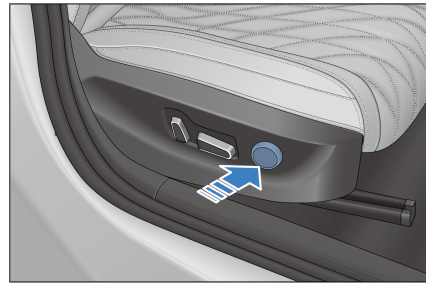

Memory System*

Memory switch position

The memory system switch is located on the trim of driver door, having a total of 2 memory positions.

Setting function

- Memory setting conditions
 - The vehicle is powered on with no vehicle speed.
 - Seats and side mirrors have been adjusted to the required positions.
 - No actions are performed by the seats and side mirrors.

Memory setting method

- Memory setting in OK mode
 - Press and release the "SET" button on the seat memory switch, and press either "1" or "2". Then the positions of the seats and side mirrors will be remembered, and the memory setting finishes.
 - Press and release the "SET" button on the seat memory switch, and press either "1" or "2" within 3 seconds. Then the positions of the seats and side mirrors will be remembered, and the memory setting finishes.

If the position button on the memory switch has already been set, the position set will be overwritten.

Memory wake-up function

Memory wake-up function in OK mode

- With the gearshift lever in the "P" position, the driver's seat memory system will perform memory wake-up operation when the memory system switch is pressed if the following conditions are met:
 - The vehicle is not in anti-theft mode.
 - No speed.
 - Memory switch signals are valid.
 - No actions are performed by the seats and side mirrors.

Heating and Ventilation Systems*

- To enable or disable the heating & ventilation function, go to Infotainment touchscreen  → A/C → Seat Operation.
- Tap "Drop-down" on the home page of the infotainment system to operate the seat heating and ventilation setting buttons.

Heating system adjustment

- Seat heating: Control the operation mode of the heating pad by using the seat heating switch. The heating function has two modes.
 - After each power-on, the driver's seat remembers the last mode, and the initial heating state of the passenger's seat is Off.
 - Press the switch to select the operation mode of the seat heater in the 1st gear or 2nd gear.
 - Press the OFF gear to deactivate the heating function.

Ventilation system adjustment

- Seats Ventilation: Control the operation mode of the ventilation fan by using the seat ventilation switch. Seat ventilation has two modes.
 - After each power-on, the driver's seat remembers the last mode, and the initial ventilation state of the passenger's seat is Off.
 - Press the switch to select the operation mode of the seat ventilation in the 1st gear or 2nd gear.
 - Press the OFF gear to deactivate the ventilation function.

Ventilation and heating functions cannot be turned on at the same time.

- Press the ventilation switch to make the ventilator work; if the heating switch is then pressed, the ventilator will stop and the heater will start to work.
- Press the heating switch to make the heater work; if the ventilation switch is then pressed, the heater will stop and the ventilator will start to work.

Folding Rear Seats

Pull up the folding release clasp on the seat back to fold the rear seat back.



CAUTION

- Fold or recover the rear seat in a normal speed to avoid quickly falling down or pulling up the back seat, which may damage the seat belts or cause abnormality.
- Ensure that the left and right seat belts expose when folding or recovering the rear seat to avoid the seat belts being stuck between the rear seat and the flanks.

Rear Seat Head Supports

Lifting Head Supports

Lift the head support to a proper position, and release it after hearing a locking sound.

Lowering Head Supports

Press and hold the head support adjustment button, lower the head support to a proper position, and release the button after hearing a locking sound.

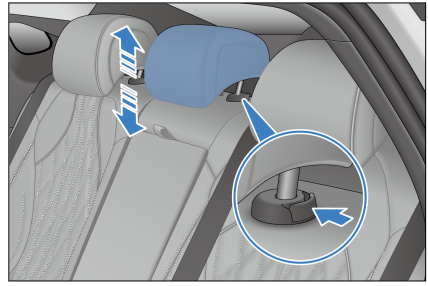

Removing The Head Support

Press and hold the head support adjustment button, remove the head support, and release the button.

Installing Head Supports

Insert the head support post into the bushing with the grooves facing forward. Press and hold the head support adjustment button, lower the head support to a proper position, and release the button after hearing a locking sound.

REMINDER

- To avoid neck injury and other head injuries, adjust the height of head support so that its center is level with the top of your ear.
- After adjusting the head support, press the head support down to confirm that it is locked.
- Do not drive the vehicle without a head support.

! REMINDER

- Do not attach any object to the head support lever.

Steering Wheel

Steering Wheel

Steering Wheel Switches

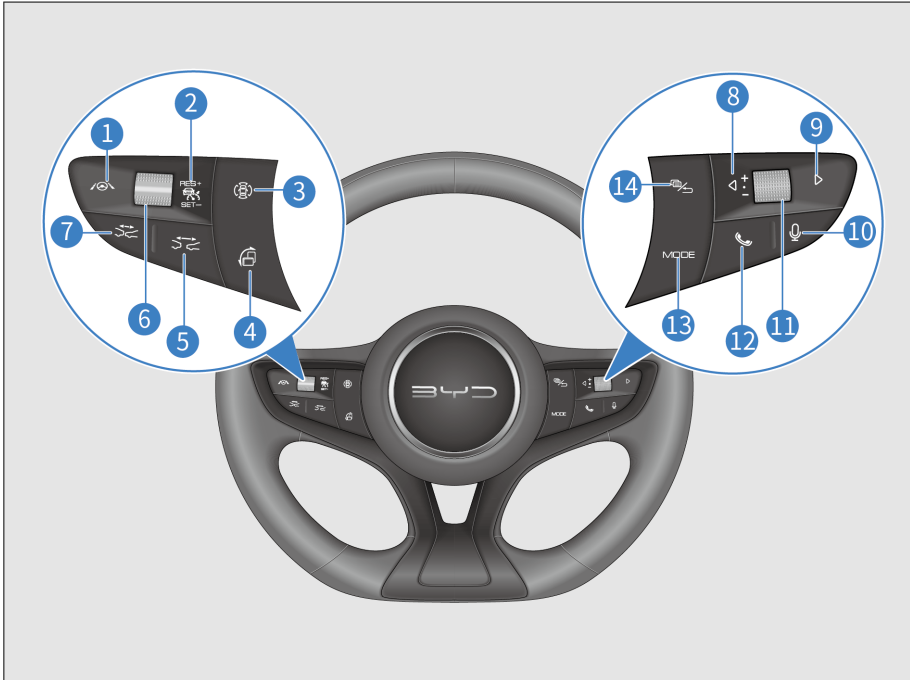

- 1 ADAS button
- 2 ACC switch
- 3 Panoramic view*
- 4 Screen mode
- 5 Distance +
- 6 +/Reset or -/Set
- 7 Distance -

- 8 Left
- 9 Right
- 10 Speech recognition
- 11 Scroll button
- 12 Call
- 13 Mode
- 14 Instrument cluster/Back

Left-hand buttons

ACC switch

- Turns the ACC system on or off.

+/Reset

- Activates the adaptive cruise control (ACC) system and uses the previous system settings.

-/Set

- Sets the current speed to the target cruise speed.

Distance -

- Reduces the distance from the vehicle ahead by one notch when the ACC function is enabled. A total of four notches are available.

Distance +

- Increases the distance by one notch when the ACC function is enabled. A total of four notches are available.



CAUTION

For instructions on how to use cruise control, see **P109**

Screen mode

Switches between the landscape and portrait mode of the infotainment system touchscreen.

Panoramic view

- Turns panoramic view off in panoramic view mode, turns it on when it is not in the mode.

ADAS button

- Turns ICC on or off.

Right buttons

Roller

1. Infotainment system

- Roll the button upward to increase volume.
- Roll the button downward to decrease volume.
- Press down the button to mute.

2. When the instrument cluster is in menu mode:

- Roll the button upward to select the upper level-2 or level-3 menu items.
- Roll the button downward to select the lower level-2 or level-3 menu items.
- Press down the button
 - to go to the next-level menu or confirm the current setting when the instrument cluster is in menu mode.
 - Confirm the current settings when setting for reservation charging.



CAUTION

- The infotainment system is muted once the instrument cluster is set to the menu mode. To adjust infotainment system volume, exit the instrument cluster menu mode first.

Left/Right buttons

1. Infotainment system

- In radio mode:
 - Press the ◀ button to select previous radio station.
 - Press the ▶ button to select next radio station.
- When the infotainment system is in USB/Bluetooth music/third-party music app/other modes:
 - Press the ◀ button to play the previous track (track number -1).
 - Press the ◀ button to select a record upward on the Bluetooth call record or phonebook screen.
 - Press the ▶ button to play the next track (track number +1).
 - Press the ▶ button to select a record downward on the Bluetooth call record or phonebook screen.

2. Instrument cluster

- When the instrument cluster is in menu mode:
 - Press the ◀ button to switch to level-1 menu and its submenus on the left.
 - Press the ▶ button to switch to level-1 menu and its submenus on the right.

Call

- Press this button to make or receive a call. (The audio system is muted at the same time.)
- When a Bluetooth-unrelated screen is currently displayed, press this button to switch to the phone selection screen if Bluetooth is disconnected, or to the Dial screen if Bluetooth is connected.
- After entering a phone number on the Dial screen or selecting a record on the Call Log or Contacts screen, press this button to dial the number.
- When Bluetooth is connected, but no phone number is entered on the Dial screen, press this button to switch to the Call Log screen. Press this button again to call the first dialed number on the call history.

Speech recognition

- Press this button for the infotainment touchscreen to switch to the voice recognition screen.
- Press this button again to re-enter a voice command.

Instrument cluster/Back

- When the instrument cluster is not in the menu mode, press this button to view the instrument cluster menu.
- When the instrument cluster is in menu mode, press this button to return to

the upper-level screen, or to exit the menu if there is no upper-level screen.

- When dialing on the Bluetooth interface, press it to end the call.

Mode

- Selecting a mode: Press the Mode button to switch between media apps, peripherals, and pre-installed third-party audio/video apps.

Horn

- Press the horn button area to honk the horn, and release to stop honking.

CAUTION

- Avoid pressing honking for too long, as the horn may be damaged.

REMINDER

- Observe the traffic laws and use the horn properly.

Adjusting the Steering Wheel Manually*

- To adjust the steering wheel position, hold it and operate as follows:
 - Push down the steering wheel adjustment handle, adjust the steering wheel to the desired position, and then return the handle to its original position.

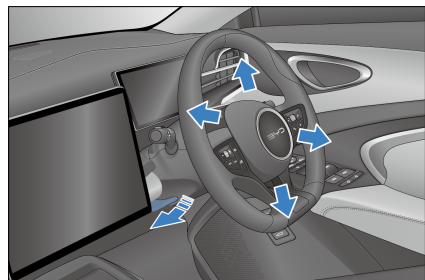

! REMINDER

- Never adjust the steering wheel while driving, as this is under risk of impaired vehicle control, which can lead to accidents.
- After adjusting the steering wheel, move it up and down to verify that it is securely locked.

Power-Assisted Steering Mode Settings

- The feel of steering assistance varies from person to person, and so do the evaluation and needs for this feel.
- To set the steering mode, go to the Infotainment touchscreen  → Vehicle Settings → Intelligent Chassis → Steering Assist setting and select Comfort or Sport.

! REMINDER

- When the vehicle is running at high speed, if you feel the steering wheel is light, it is suggested to set the power-assisted steering mode to sport mode.

Steering Wheel Heating*

- Turn on/off steering wheel heating in infotainment touchscreen → A/C interface → Vent/Heating → Steering wheel heating.
- You can turn on the steering wheel heating remotely through BYD app interface → Vent/Heating → Heater to gain a comfortable interior environment in advance.

Switches

Light Switches

Set the light switch to  to turn off all lights except for daytime running lights.

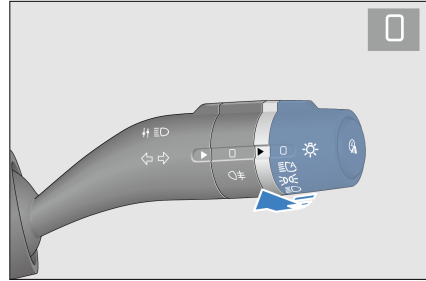
**Auto lights**

Set the light switch to . The body control module captures the brightness data from the light intensity sensor to automatically turn the position lights and low beam on or off.

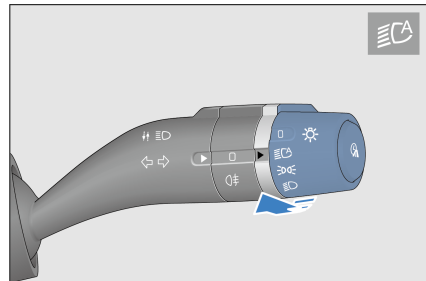
**! REMINDER**

- The light intensity sensor is located on the top of the windshield. Do not block the sensor or let anything splash on it.

Position lights

Set the light switch to  to turn on position lights.

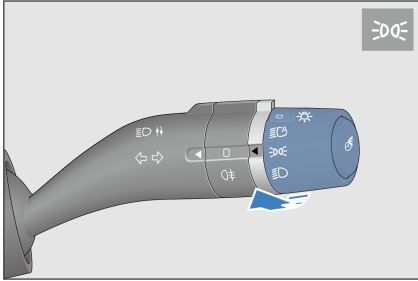

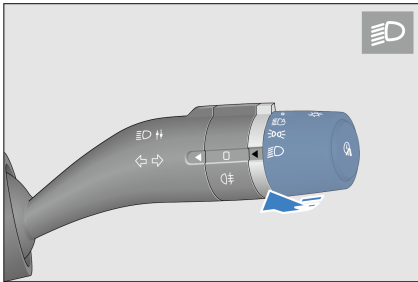

Low beam

Set the light switch to  to turn on the low beam.



Rear fog lights

Set the light switch to  and rotate the fog light dial to  to turn on rear fog lights.

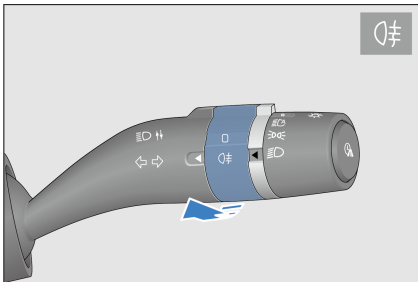

High beam

Set the light switch to  and push the light switch handle down (away from the steering wheel) to turn on the high beam.

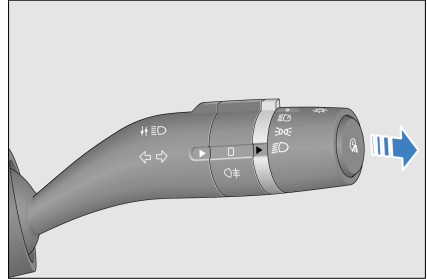

Overtaking light

Pull up the light switch handle (toward the steering wheel) to turn on the overtaking light. Release the handle for the light switch to automatically reset. The overtaking light turns off.

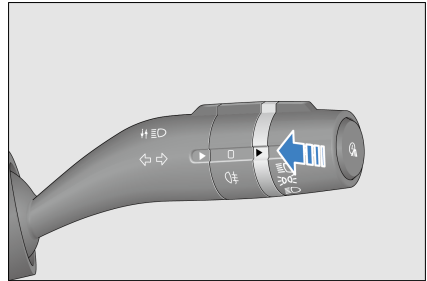

Turn signals

- Push up the combination switch light handle. The left turn signal and the turn signal indicator on the instrument cluster starts flashing at the same time.
- Pull down the combination switch light handle. The right turn signal and the turn signal indicator on the instrument cluster starts flashing at the same time.

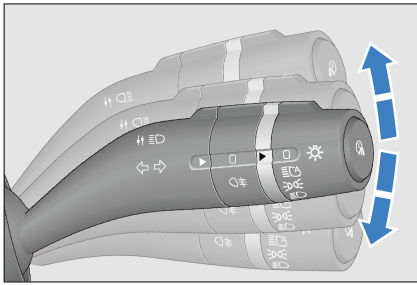

! CAUTION

- Once turned on, turn signals continue flashing even after the handle is released. They will turn off after the vehicle goes around the bend. Depending on the driver's habit, the turn signal will reset after the vehicle turns around under some extreme conditions.

Auto light off

- Conditions to activate the auto light off function: To activate this function, set the light switch to or and switch off the vehicle power.
- With the function is activated, the headlight, position light, rear fog light and high beam turn off in 10 seconds if the driver's door is closed.
- When the function is activated, the headlights and position lights turn off in 10 minutes if the driver's door is open.
- After the lights turn off automatically, if the light status changes, these lights come on in the new status. If the conditions to activate the auto light off function are still met, the function is activated again.
- Disabling of the auto light off function: When the vehicle is powered on, the auto light off function is disabled,

and the light switch can be operated normally.

- When the auto light off function has turned off the lights and anti-theft mode has been activated, if you deactivate anti-theft function, the lights come on again automatically. If the driver's door remains closed, the lights go off again in 10 seconds. But if any door is open, it turns off the light in 10 minutes.

Advanced turn-on/delayed turn-off (Follow me home)* of headlights





- Delayed turn-off of headlights:
 - When the combination switch is turned to "", " " or " " and you are about to leave the vehicle and set the power mode to "OFF", execute the "Follow me home" function, corresponding lights will light up for 10s (or a set time) and the light off.
- Advanced turn-on of headlights:
 - When the combination switch is turned to "", " " or " " and you approach and unlock the vehicle to execute the "Follow me home" function, corresponding lights will light up for 10s (or a set time).

! CAUTION



- The time for the advanced turn-on/delayed turn-off of the headlights is 10s by default, but you can change it in the infotainment interface.

Wiper Switch

Front Windshield Wipers and Washer

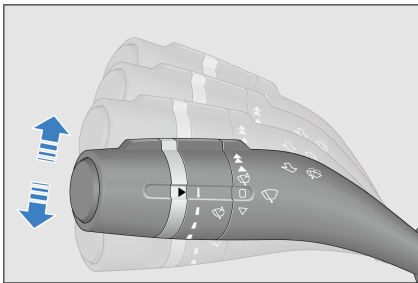
- The lever is used to control the windshield wipers and washer. It has five modes:
 -  : High-speed
 -  : Low-speed
 -  : Auto Wipers/Intermittent
 -  : Stop
 -  : Point-wiping



- To select a mode, push up or pull down the lever.
- At low- and high-speed modes, the wiper operates continuously.
- To let wipers work in the spot-wiping mode  , pull the lever from the  position. The wipers wipe at a low speed until you release the lever.

Auto Wipers/Intermittent

- The rain sensor automatically controls the operation mode of wipers based on the rainfall, and it is located in front of the interior rearview mirror on the front windshield inside the vehicle.
- To use the automatic wiper function, turn the wiper switch to the automatic mode, go to the Infotainment

touchscreen  → Vehicle Settings → Greeting and toggle Automatic Wiper on.

- To use the intermittent wiper function, turn the wiper switch to the automatic mode, and toggle Automatic Wiper off in Infotainment system  → Vehicle Settings → Greeting.
- The automatic wiper function has four sensitivity levels. The higher the lever, the higher the sensitivity. When using the automatic wiper function, change the sensitivity by adjusting the toggle based on real-time rain conditions. If the wiper reacts to rain too quickly, reduce the sensitivity; if the wiper reacts to rain too slowly, increase the sensitivity.

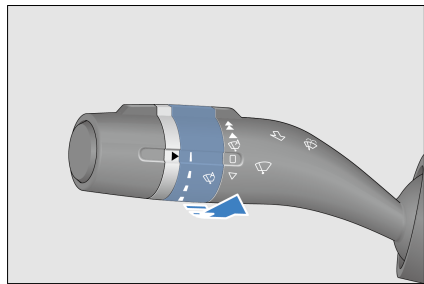

Front Windshield Wipers and Washer

- The front windshield washer spray and wiper are activated when the stick is pulled back towards the steering wheel.
- The washer spray will stop when the stick is released, and the wipers will operate twice then stop.

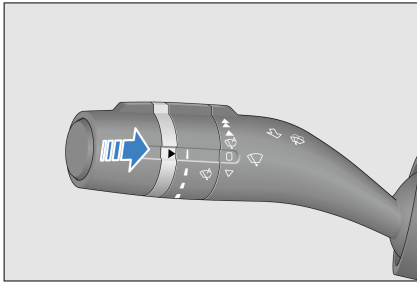

Driver's Door Switches

Power Window Switches

- When the ignition switch is on OK, all the window switches can lift up and down the window. After the vehicle is powered OFF, no power windows can be regulated.

Driver side windows control switch

There are two gears of window control, like the figure ① and ②.

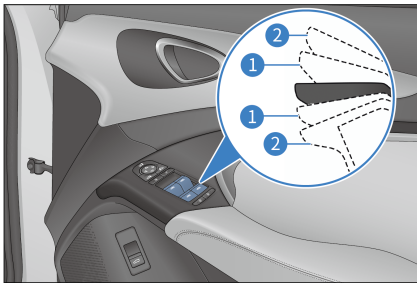

Manual operation

- Press the window regulator switch to ① mode position and keep it (for vehicles without anti-pinch function, directly press and hold the window regulator switch) to lower the window; releasing the switch can immediately stop the window lowering; pull up the window regulator switch to ① mode position and keep it (for vehicles without anti-pinch function, directly pull up and hold the window regulator

switch) to raise the window; releasing the switch can immediately stop the window raising.

Auto lifting

- Press the window regulator switch to ② mode position and release it to automatically lower the window; pull up the window switch to ② mode position and release it to automatically raise the window.

Anti-pinch function

- The anti-pinch function automatically stops the window glass from closing and withdraws it a certain distance, if an obstruction is sensed while the window is closing.

! REMINDER

- Do not intentionally test the anti-pinch function by jamming any part of your body into the window.
- The anti-pinch function may not work if an object is jammed into the window when it is almost completely closed.
- Windows with anti-pinch function can control opening or closing the window by "intelligent voice assist".

Automatic window rolling-up and anti-pinch failure

- If the window working indicator flashes, the automatic window closes and anti-pinch functions fail, follow the steps given below to restore the functions.
- Pull up and hold the manual closing gear of the regulator switch to allow the window to lift to the top position and keep the window stall at the top position for 400 ms, until the switch indicator changes

from flashing to staying on. This means that initialization has been completed. The anti-pinch module has all functions except the soft stop function. When the window glass runs down to the locked rotation (400 ms), it has a soft stop function.

Delay function

- After the vehicle is powered off, if the front doors are not open, the four-door window controller has a 10min roll-up/down delay period. During this period, the windows can still be rolled up and down. If either of the front doors is opened during this period, the delay function is canceled, and the four-door window controller can no longer be used to operate the windows.

WARNING

- Before closing a power window, ensure passengers' hands are not placed upon the window glass; pinching of hands or fingers can result in serious injuries.

Window lock button

- After pressing the "window lock" button, the driver can control the windows on the four doors, and the window regulator switches on the rear passenger sides are turned off with indicators off at the same time.

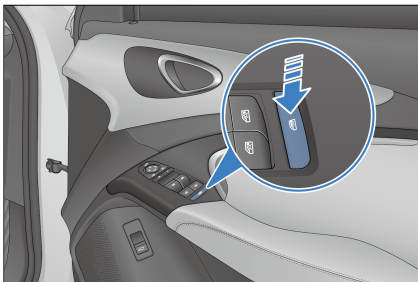

Central Locking

The driver door is equipped with power door lock switches. Both switches can lock or unlock all doors.

① Locking

Press the central lock button. All doors are locked and the red lock indicator lights up.



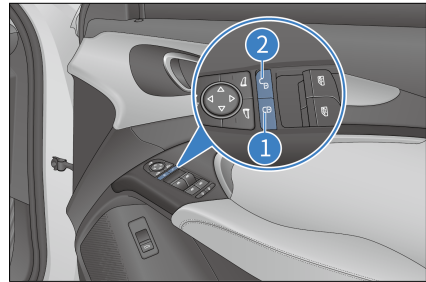

② Unlocking

Press the central unlock button. All doors are unlocked and the red lock indicator turns off.



Side Mirror Switches

Side mirror selection buttons

-  : Left side mirror button
-  : Right side mirror button
-  : Side mirror adjustment buttons
 - Press this button to adjust the side mirror lens to a right position.
-  : Power side mirror fold switch
 - Press this button to fold the side mirrors.

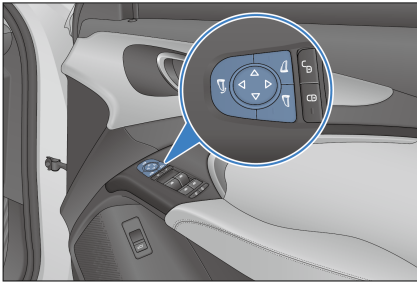

! REMINDER

- If the side mirrors are frozen, use a jet deicer to clean the mirror surfaces rather than operating the controller or scraping them.

Window Control Switch on Passenger Side

When the ignition is on, use the front left and rear door window switches to operate the respective windows.

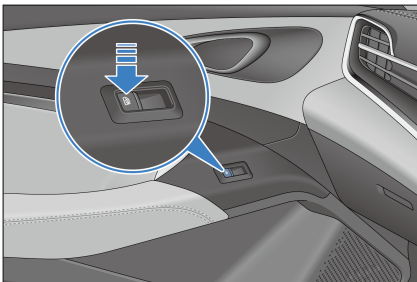

Odometer Switch

- Press the odometer switch to switch between "Total Mileage" - "Mileage 1" - "Mileage 2" - "Total Mileage". The switching status is displayed accordingly on the instrument cluster.

- Press and hold "Mileage 1" and "Mileage 2" to clear the mileage information.

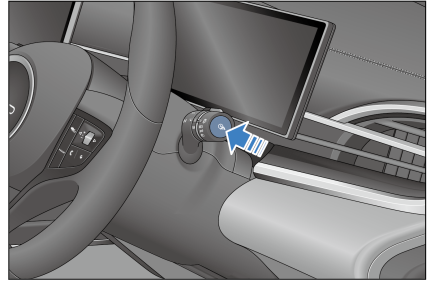

Mode Switches

① Snow mode button

- Press down the snow mode switch ① to put the vehicle in snow mode.
- This mode is recommended on fairly strong surfaces that are covered with a layer of loose and slippery materials (e.g., grass, snow, ice, or gravel).
- Snow mode optimizes the towing, driving, and manipulation features in slippery conditions, and the accelerator pedal is selected with caution.

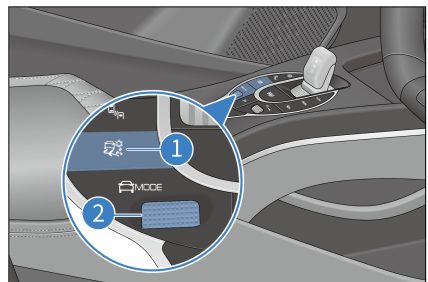

! CAUTION

- Shutting down the ESC system may help if the motor

CAUTION

performance is degraded in soft snow conditions by the activation of dynamic stability control. The ESC system must be restarted after conditions are back to normal.



- Roll the scroll button ② to switch ECO, NORMAL and SPORT modes cyclically.

Front Passenger Airbag Switch (PAB)

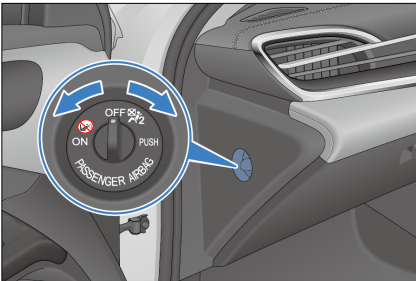

Front passenger airbag switch (PAB switch)

- Turn the PAB switch (if provided) to "ON" or "OFF" to enable or disable the front passenger front airbag.
- Before driving, repeatedly check the PAB switch status based on the seating situation of the front passenger seat to confirm that the PAB is in the correct state.



- Enable or disable the front passenger airbag according to the use of the front passenger seat:
 - When the switch is ON, the front passenger airbag is activated. The passenger airbag indicator "PASSENGER AIRBAG" is solid on, "ON" and  come on, and "OFF" and  are off. The front passenger

airbag deploys in the event of a moderate to severe collision that meets the necessary deployment conditions.

- When the switch is OFF, the front passenger airbag is deactivated. The passenger airbag indicator "PASSENGER AIRBAG" is solid on, "ON" and  are off, and "OFF" and  come on. The front passenger airbag do not deploy in the event of a moderate to severe collision that meets the necessary deployment conditions.



WARNING

- When the front passenger seat is occupied with an adult, the PAB switch shall be turned to "ON" to always keep the PAB enabled.
- When the front passenger seat is occupied with an infant or child in a rear-facing child seat, the driver shall check that the PAB switch is off and the PAB is disabled.
- If the PAB is enabled when the PAB switch is off, please immediately contact a BYD authorised dealer or service provider.
- If the recommendations above are not followed, there is a high risk of serious passenger injury or even casualty.

CAUTION

- To prevent damage to the airbag system, please operate PAB switch when the vehicle is on "OFF".
- The rear seat is the preferred choice for installing a child seat.

Hazard Warning Light Switch

When the  button is pressed, all turn signals and turn signal indicators on the instrument cluster start flashing. They all stop flashing when the  button is pressed again.

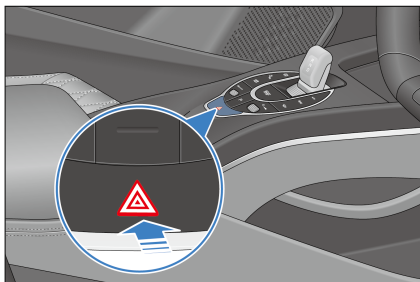

CAUTION

- The hazard warning lights are used to alert drivers and pedestrians of possible risks.

Emergency Call (E-Call)*

E-Call status indicator

E-call is short for “emergency call” . When the user's vehicle suffers a serious collision, or is involved in an emergency, pressing this button connects to the call center with the highest priority. The customer service personnel will obtain important user and vehicle data, and will assist the user in escaping danger, dispatching an ambulance to the scene immediately if necessary to ensure the user's safety.

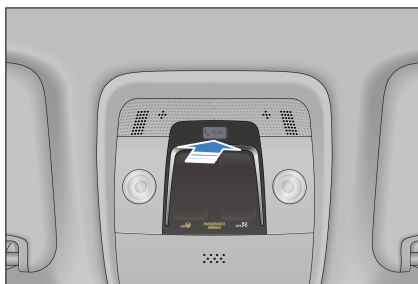

- Pressing and holding the SOS button on the interior rearview mirror for 1 second $\leq t \leq 10$ seconds triggers the E-Call system manually, and pressing and holding the button for 10-20 seconds does not.
- To cancel an emergency call made by mistake, press the SOS button a second time within five seconds.
- The E-Call system activates automatically in the event of airbag deployment or the detection of a severe collision.
- When triggered, the system automatically makes an emergency call and communicates standard information to a public safety answering point.

CAUTION

- The SOS button will be considered to be short-circuited (button stuck) if you press and hold the SOS button for over 20 seconds. In that case, the E-Call cannot be triggered manually.
- The dialed emergency call cannot be canceled manually. The E-Call system will begin 60-minute callback time after the call is hung up by the public safety answering point or has not been answered 10 consecutive times.

Status Description	LED indicator	Beeping
Ignition off or E-Call system failure	Off	\
Power-on self-check mode	Flashing fast - 2 Hz	\
Ignition on and self-check passed	Solid on if self-check is passed	\
E-Call connecting	Flashing - 1 Hz	A beep
E-Call connected	Flashing - 1 Hz	A beep
E-Call ended	Solid on	Two beeps after E-Call ends
60-minute callback time	Flashing extremely slowly - 0.2 Hz	\

Interior Light Switch

Configuration 1 Front Interior Lights Switches



Configuration 2 Side Interior Light Switch

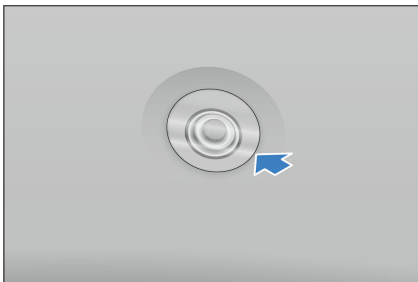

With the ignition off and DOOR option selected, interior lights will go off after the door have remained open for a period

of time. If there are other operations during this period, the timer will be restarted. (To turn on or off the “DOOR” gear, slide down the top status bar on the infotainment screen to display the shortcut page.)

Ambient Lights

To control the brightness, color and area of the ambient light, go to infotainment touchscreen  → **Vehicle Settings** → **Ambient Light**.

04

USING AND DRIVING

Charging/Discharging.....	76
Battery.....	91
Usage Precautions.....	94
Starting and Driving.....	101
Driver Assistance.....	109
Other Main Functions.....	141

Charging/ Discharging

Charging/Discharging

- The charging equipment is a high-voltage electrical device. Minors are prohibited to charge or touch it. Keep minors away from the vehicle when charging.
- Charging may affect medical or implanted electronic devices. Consult the device manufacturer before charging.
- Charge the vehicle in a relatively safe environment, and avoid charging in damp areas, or areas with fire or heat sources.
 - Protect the charging equipment against water contact on rainy days.
- Before charging:
 - Ensure that power supply equipment, charging connector, charge port, and charging connection device are free of defects, such as cable wear, rusted ports, cracked casings, or foreign objects in the ports.
 - Do not charge the vehicle when the charging connector's or port's plug, socket, or metal terminals are loose or damaged by rust or corrosion.
 - When the charging connector, port, power plug, or socket is visibly stained or damp, wipe them with a dry and clean cloth to ensure the connection is dry and clean.
- Use charging equipment that complies with local standards.
 - To avoid charging failure or fire, do not modify, disassemble, or repair the charging equipment and related ports.
- Do not use charging equipment that does not meet safety standards or has potential safety hazards. Do not allow children to use the charging equipment and keep animals away from the vehicle while charging.
- Ensure that your hands are properly dry before charging.
- If anything abnormal is found in the vehicle or charging equipment when charging, stop immediately and contact a BYD authorized dealer or service provider.
- Always observe the following charging precautions to prevent damage to the vehicle:
 - Do not shake the charging connector, otherwise the vehicle charge port may be damaged.
 - Whenever possible, do not charge the vehicle during a thunderstorm, under risk of lightning strikes.
- Do not open the hood for maintenance while charging.
- After charging, do not disconnect the charging equipment with wet hands or while standing on any wet surface.
 - Before driving, ensure that the charging equipment is disconnected from the charge port.

Charging Precautions

- When the state of charge (SOC) is low, the instrument cluster turns red, it indicates that the high-voltage battery is about to be exhausted. Please charge it immediately, otherwise it will reduce the high-voltage battery service life and influence your driving experience.

- Mode 2 charging means charging with an AC charging connector that complies with local standards. It is recommended to use the dedicated AC lines and power sockets meeting local standards to avoid line damage and protective trip due to high-power charging, affecting the normal use of other equipment.
- Avoiding damage to the charging equipment (precautions for charging equipment):
 - Prevent the charging equipment from suffering any mechanical impact.
 - Do not place the charging equipment near heaters or other heat sources.
- Before charging:
 - Make sure that the charging connector and charge port are free of foreign objects, and that the protective cap of the charging connector terminal does not get loose or deformed.
 - Hold the charging connector, align the connector with the charge port and push it in, making sure that they are properly connected.
- When charging is complete:
 - Stop charging first and make sure the charge port is unlocked.
 - Pull the charging connector.
 - Do not force the charging connector out while the charge port is locked, otherwise the charge port may be damaged.
- Switch the ignition off before charging.
- Precautions:
 - The vehicle can be powered on to use the A/C while charging. To ensure the charging power, it is recommended to turn off the A/C.
 - The vehicle should be parked in a ventilated area, and there should not be any occupant inside when charging.
 - The vehicle system automatically stops charging when the high-voltage battery is fully charged.
 - To stop AC or DC charging, turn off the charger before disconnecting the charging connector. In Mode 2 charging, remove the charging connector and then the power plug.
 - When charging is complete and the charging connector is unplugged, make sure that the charge port's cap and door are closed, otherwise water or foreign materials may enter the port and affect its normal use.
 - During DC charging, the DC charging power is relatively small during the identification period to identify the real capability of the charging pile and allow the charging pile to exert its maximum output capacity, thereby bringing a better charging experience to users. (only for motor booster DC Charge).
 - Before starting the vehicle, ensure that the charging equipment is disconnected. The locking mechanism can damage the charging equipment and the vehicle if the vehicle is started with the charging connector incorrectly inserted.
 - When the temperature is low, it is recommended to charge the vehicle in heated space indoors.
 - When the temperature is high, charging in a cool, ventilated place is recommended.
 - Battery temperatures that are too low or too high compromise vehicle charging performance.
 - The temperature control system can improve low-temperature charging capacity of the battery. Due to output

capacity limitations of charging piles, the charging time is extended, the heating time becomes longer and the power consumption of heating is increased. It's the normal phenomenon.

- For faster low-temperature DC charging, charging from low SOC is recommended because, due to the low battery temperature, the charging current is small for vehicles with high SOC in low-temperature environments.
- To improve your experience at low temperatures, it is recommended that you charge the vehicle immediately after using it, as the battery is relatively hot and has better charging performance.
- Turning A/C on during low-temperature charging affects the performance of battery temperature control system and charging performance.
- It is normal that when the battery temperature control system is working during charging, the charging power displayed on the instrument cluster may fluctuate temporarily.
- Before charging is complete, battery equalization is activated for longer battery life and thus the charging time may be longer.
- The use of A/C may worsen battery temperature control system performance in DC charging at high temperatures, resulting in lower charging performance and longer charging time. To ensure charging efficiency, it is recommended to keep the A/C off during charging.
- When the heating or cooling function is enabled during charging, it is normal that both charging time and power consumption increase slightly.

- During charging, battery cooling may start, and the compressor, fan and other components work when necessary. It is normal that there will be some noise under the hood.
- During charging, the estimated remaining time to full charge is displayed on the instrument cluster or infotainment touchscreen. It is normal that the remaining time to full charge may vary slightly, depending on the temperatures, SOC, and charging facilities. Before charging is completed, "Calculating..." is displayed on the instrument cluster.
- If the charge port door is frozen due to weather or other reasons, do not force it open.
- If the vehicle will not be used for longer periods of time afterwards, make sure to fully charge its high-voltage battery before use. In case of idle periods, it is recommended to charge the battery every three months in order to prolong its service life.



REMINDER

- Do not open the charge port door forcibly when it is locked.
- Do not force the charging connector in or out while the charge port is locked.
- Do not close the charge port door when the port cap is fully open.
- When the vehicle is charged with an external power supply, it is normal that the cooling fan and A/C compressor may operate automatically for the high-voltage battery to cool down.

Charging Method

The pure electric vehicle is driven by electric energy supplied from high-

voltage battery. To prevent insufficient high-voltage battery affecting the vehicle driving experience, it is very important to charge the vehicle in time and estimate the power demand before driving.

Vehicle Charging Method:

1. Using Mode 2 Charging Cable*
 2. Using AC Charging Piles*
 3. Using DC Charging Piles*
- The charging time of high-voltage varies with the charging mode, current SOC, real-time temperature, service time, ambient temperature and other conditions.

- Use charging equipment that complies with local standards.

Charging Mode

- Charging Reservation (Only AC): Charge the vehicle regularly at a scheduled charging time set by the user.
- Immediate charging: Charging starts after the charging connector is connected.

General Charging Troubleshooting

Fault	Possible Cause	Solution
Charger is connected, charge starts, but battery is not charged	The high-voltage battery has been fully charged	When the high-voltage battery is fully charged, the charging will stop automatically.
	High-voltage battery temperature is too high or too low	Keep the vehicle in an environment with appropriate temperature and charge it when the temperature becomes normal.
	Low-voltage Battery over-discharging	Please replace the low-voltage battery.
	Charging equipment failure	If it is verified that the charging equipment's power indicator is working properly, or that there are no other unusual indications, change the charging equipment or contact the charging equipment supplier.
	Vehicle display fails	Verify that there is a charging system fault message on the instrument cluster, then stop the charging. It is recommended to contact a BYD authorized dealer or service provider.
Charging stops midway	AC grid outage	During AC charging, if power supply resumes after short-time outage of the external power grid, BYD charging equipment will re-start charging automatically and no re-connection of the charging equipment is required.
	Charging cable is not connected properly	Verify that the charging connection cable is not loosely connected.

Fault	Possible Cause	Solution
	Charging connection switch is pressed	If the charging connection switch is pressed, the charging will stop. The charging connection should be connected again to start charging.
	High-voltage battery temperature is too high or too low	If the instrument cluster shows the high-voltage warning light, the charging will automatically stop. Charge the vehicle when the battery temperature returns to a normal level.
	Vehicle or charging pile failure	If there is any fault prompt for the charging pile or the vehicle, it is recommended to contact a BYD authorised dealer or service provider.

Charging

- Check before charging:
 - Check the charging device for abnormalities such as cracked housing, worn cable, rusted plug, or foreign materials.
 - Do not charge when the charging connection becomes loose.
 - Make sure the port is clear of fluids or foreign objects, and its metal terminals are not rusty or corroded.
- In any of these cases, do not charge. Otherwise, personal injury may occur due to short circuit or electric shock.

Using Mode 2 Charging Cable*

1. Equipment

- Connect the vehicle to an outlet that meets local standards to charge the vehicle.
- A household socket meeting local standards must be used in order to avoid line damage or tripping due to high-power charging, which may effect the normal use of other devices.
- This EV Mode 2 charging cable includes a power plug (complying with local standards), a charging connector, a

control box, and a charging cable. The plug is connected to a standard household power socket, and the charging connector to the vehicle's charge port.

- Charging time: Refer to the charging time message on the instrument cluster.

WARNING

- See "Charging Instructions" for charging safety warnings.
- The highest working temperature allowed for the product is 50°C. Store the product in a cool and dry place when it is not in use.
- When charging, do not place the equipment in the trunk, under the front of the vehicle, or near the tires.
- When using the equipment, prevent it from getting rolled over by the vehicle, dropped, or trampled on.
- Never drop the equipment or pull it directly by its cable. Take caution when moving the equipment.

! WARNING

- It is strictly prohibited to modify, disassemble, or repair the charging equipment and its ports.
- It is not recommended to use any additional wire or adapter/connector. If an additional adapter is required, choose a suitable cable diameter ($\geq 1.5 \text{ mm}^2$) and the adapter/connector parameters must meet requirements.
- Never use the charging equipment if the household power strip cable becomes soft, if the charging connector cable is worn out, if the insulation layer is cracked, or in case of any other damage.
- Never use the equipment when the charging connector, power plug, or power strip is disconnected or broken, or if there is any sign of surface damage.
- To prevent failure of the charge port door, do not open and close it repeatedly. The recommended time interval for opening and closing the port door is at least one second.

! CAUTION

- The charging cable must not be placed in a spiral during charging, as this will affect heat dissipation.
- See the charging instructions for specific charging precautions.

! REMINDER

- It is recommended to contact a BYD authorized dealer or service provider or local electrician to

! REMINDER

- select an appropriate power supply according to requirements of the charging equipment.
- Charging equipment grounding instructions: The equipment must be properly grounded. In the event of failure or damage to the equipment, the grounding cable provides a minimum impedance to circuit discharge and thereby reducing the risk of electric shock.
- The equipment comes with a ground cable connecting its ground point with that of the power plug, which must match a properly installed and well-grounded power supply outlet.

2. Charging

- With the vehicle doors unlocked and preferably powered off, press the charge port door to open it.



- Open the charge port cap, and make sure that no obstacles exist between the head of the charging connector and the end of the charging socket.

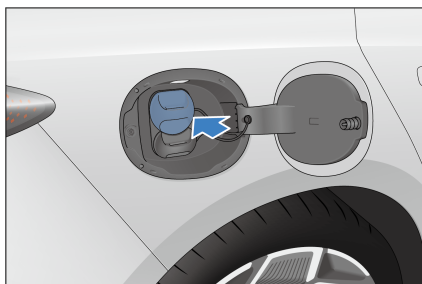

! REMINDER

- Do not open the charge port door forcibly when it is locked.
- If the charge port door is frozen due to weather or other reasons, do not force it open.
- Connect the power supply terminal:
 - Plug the EV Mode 2 Charging Cable into a household socket.
- Connect the vehicle port:
 - Plug the charging connector correctly into the port.
- After the charging connector is inserted, the charging connection indicator  lights up on the instrument cluster.

! REMINDER

- Do not forcibly insert the connector with the electric lock engaged.
- In the charging process, charging parameters and the charging sign are displayed on the instrument cluster.
 - At this point, you can schedule charging on the infotainment touchscreen. See "Reservation Charging" for the configuration process.

! REMINDER

- During charging, the estimated remaining time to full charge is displayed on the instrument cluster or infotainment touchscreen. It is normal that the remaining time to full charge may vary slightly, depending on the temperatures, SOC, and charging facilities.
- Reservation charging cannot be used when the battery is too low.

3. Stopping charging

- End the charging:
 - The charging automatically ends when the vehicle is fully charged.
 - Press the unlock button on the smart key or press the door handle microswitch (while carrying the smart key), then the vehicle will stop charging.*
- Disconnect the charge port:
 - If the anti-theft lock is deactivated, press the mechanical button of the charging connector or pull out the charging connector as needed.
 - If the anti-theft lock is active, press the unlock button on the key or press the door handle microswitch (when the key is nearby), then pull out the charging connector.

! REMINDER

- To unlock the vehicle, press the unlock button on the key (when charging the vehicle with ignition switched off) or press the microswitch on the door handle (when the key is nearby).

! REMINDER

- When anti-theft is enabled, unlock the vehicle to release electrical lock of the charge port before pulling out the charging connector. The connector has to be pulled out within 30 seconds, or the port will re-lock.
- You can activate the anti-theft lock on the infotainment touchscreen, as detailed in "Charge Port Anti-theft Lock" in this chapter.
- If the charging connector cannot be removed after unlocking, try a few more unlocking attempts. If that does not work, try emergency unlocking. For the operating procedure, see "Emergency Unlocking of the Charge Port" in "Charge Port Anti-theft Lock".
- When the charge port's anti-theft mode is deactivated, if you cannot pull the charging connector out directly, try to unlock the vehicle and pull it again.

- Disconnect the power plug.
- Close the charge port cap and the port door.
- Store the charging equipment properly.

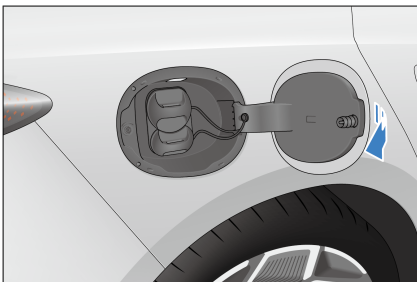

! REMINDER

- Do not close the charge port door when the port cap is fully open.

! WARNING

- Never drop the EV Mode 2 Charging Cable or pull it directly by its cable. Take caution when moving the equipment. Store the equipment in a cool place after use.

Using AC Charging Piles*

1. Equipment descriptions

- AC charging box
 - Use a standard-compliant household charging box. For how to use the charging equipment, refer to its user manual and follow the operating steps.
 - AC charging box: Consists of a charging box, a charging connector, and a connecting cable. For information on circuit breaker and emergency stop switch, see the charging box user manual.
- AC charging pile
 - Charge the vehicle using an AC charging pile in a public place.
 - Charging time: Refer to the charging time message on the instrument cluster or infotainment touchscreen.

2. Charging

- Unlock the vehicle and open the charge port door:
 - Close the charge port cap and the port door (see instructions for mode 2 charging).
- Connect the vehicle port:

- Plug the charging connector into the port and make sure it is tight.
- Charging settings:
 - For AC charging pile/box subject to authentication, swipe the card or scan the QR code. See the user manual for charging pile/box for details.
- The charging connection indicator  lights up on the instrument cluster.
- In the charging process, the instrument cluster displays relevant charging parameters and the charging sign.
 - At this point, you can schedule charging on the infotainment touchscreen. See "Reservation Charging" for the configuration process.

3. Stopping charging

- End the charging:
 - Charging ends automatically when early stop time is due or charging is complete.
- Disconnect the charge port:
 - Disconnect as per the instructions for mode 2 charging.
- Close the charge port cap and the port door (see "Using Mode 2 Charging Cable").
- Store the equipment properly.
 - If using an AC charging pile/box, place the charging connector in its designated location in the charging pile/box.

Using DC Chargers*

1. Equipment descriptions

- Use the DC battery charger in public places to charge the vehicle. Generally,

it is installed in a specific charging station.

- Equipment specifications: Please check the instructions for the charger.
- Charging time: Refer to the charging time message on the instrument cluster or infotainment touchscreen.

2. Charging

DC charging is achieved by connecting the vehicle to a DC charging connector via its connector.

- Unlock the charge port door, then open the port door and cap.
- Connect the vehicle port:
 - Plug the connector into the port, making sure it is tight.
- Operate the charging equipment to start charging.

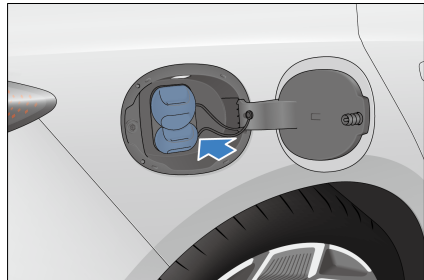

- The charging connection indicator  lights up on the instrument cluster.
- In the charging process, the instrument cluster or infotainment touchscreen displays relevant charging parameters and the charging sign.

3. Stopping charging

- End the charging:
 - Charging ends automatically when early stop time is due or the charging is complete.

- Press the unlock button twice within three seconds or press the microswitch on the door handle to stop charging.*
- Disconnect the charge port:
 - Press the unlock button on the smart key or press the door handle microswitch while carrying the smart key and pull out the charging connector.
- When the DC charging pile charging is complete, organize the charging equipment and store the charging connector in its designated position properly.
- Reinsert the DC charge port cap and close the port door.

REMINDER

- When the port cap is fully open, do not close the charge port door.



CAUTION

- If the charging connector cannot be removed after unlocking, try a few more unlocking attempts. If that does not work, try emergency unlocking. For the operating procedure, see "Emergency Unlocking of the Charge Port" in "Electric Lock Control of the Charge Port".
- To unlock during DC charging, press the unlock button twice within three seconds for the operation to be successful.
- See the charging instructions for specific charging precautions.

WARNING

- See section "Charging Instructions" for charging safety warnings.

Charging Reservation (Only AC)

- The charging mode can be set on the infotainment system. To access the setting:
 - Tap Infotainment system  → New energy to go to the "Reservation charging" page.
 - To enter the setting page, say "Hi BYD, start reservation charging", "Hi BYD, I want to make reservation charging" or "Hi BYD, please help me start reservation charging".
- Exit the Reservation Charging screen by tapping the Back  or Home  .
 - To exit the page, say "Hi BYD, end reservation charging" or "Hi BYD, exit reservation charging".

Setting screen

- ① Reservation charging
- ② Charging start and end time
- ③ Repeat cycle
- ④ Settings

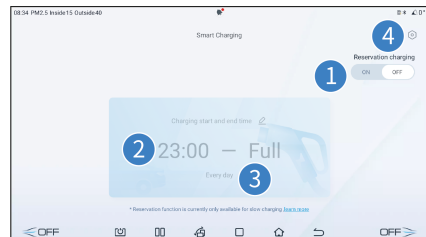

- The factory default setting is to charge the vehicle immediately. That is, reservation charging is disabled.

- To schedule a charging, toggle the reservation charging ON①, set the charging start time② and repeat cycle③, and save the settings.
- After the reservation is set up, if you connect the charging connector or press the power button to power off the vehicle during the charge waiting period, you will be reminded through the infotainment touchscreen that reservation charging has been set. Switch to instant charging if needed.
- You can tap the Smart Charging setting icon④ to turn off the charging connector connected alert and power-off alert in the Reservation charging.

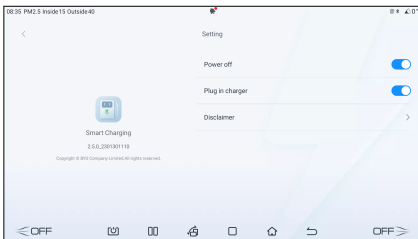

! REMINDER

- The instant charging option on the reminder screen is valid for the current reservation only. To cancel all reservations, toggle charging reservation off on the corresponding setting screen.
- The reservation charging function is only dedicated for AC charging piles provided by BYD. If you need to use this function via a public charging facility, please make sure that the facility supports vehicle-terminal reservation.
- In the event of low battery, the vehicle is charged to the minimum level before scheduled charging begins. In this process, the infotainment system still

! REMINDER

gives reminder messages for power-off and charging connector connection, and a related message is displayed at the lower part of the instrument cluster.

- The schedule setting is invalid for DC charging. Charging begins immediately after a DC charging connector is connected.

! CAUTION

- The scheduled charging function is only developed for slow AC charging equipment supplied by BYD. Please disable this function when using slow AC charging equipment that is not certified by BYD. Otherwise, scheduled or immediate charging may fail due to no response from the equipment, resulting in insufficient battery power or even lack of electricity.

Smart Charging

- When the high-voltage battery is sufficient and the low-voltage battery is tested low by the system, the high-voltage battery would be triggered and charge the low-voltage battery through high-voltage battery.

! REMINDER

- When the vehicle is stored for a long time, the smart charging function may be activated, which is normal.
- Power for smart charging comes from the power battery pack, so it is normal that an SOC decrease



REMINDER

is noticed when the vehicle is powered on.

Discharging Device

- This vehicle features a vehicle to load (VTOL) function.



WARNING

- Do not touch any metal terminal of the discharging socket or vehicle charge port during discharging.
- Stop discharging immediately if there are any abnormalities such as peculiar smell and smoke.
- See "Charging Instructions" for charging safety warnings.
- Store the product in a cool and dry place when it is not in use.
- When discharging, do not place the device in the trunk, under the front of the vehicle, or near the tires.
- When using the device, prevent it from getting rolled over by the vehicle, dropped, or trampled on.
- Never drop the device or move it by pulling it directly by the cable. Take caution when moving the device.
- Never use the charging device if the power strip cable becomes soft, the charging connector cable is worn out, the insulation layer is cracked, or any other damage occurs.
- Never use the device when the discharging connector or power



WARNING

strip is disconnected or broken, or when there is any sign of surface damage.



CAUTION

- Avoiding damage to the discharging equipment (precautions for discharging equipment):
 - Prevent the discharging equipment from suffering any mechanical impact such as dropping or hitting.
 - Do not place the discharging equipment near heaters or other heat sources.
- Before discharging, please confirm the vehicle SOC and estimate the remaining driving range.
- Before VTOL discharging, ensure that the load is turned off.



REMINDER

- Try to use this function when the SOC is high.
- The VTOL function is restricted when the vehicle SOC is low.
- The static power consumption of the vehicle will increase if, when the vehicle is powered off, the VTOL connection device is connected for an extended period without any output. Therefore, removing the discharging/charging connector when the device is not used is recommended.

External Discharging Method

Discharging

- Before discharging, turn off the anti-theft mode of the vehicle.
- Unlock the charge port door, then open the port door and cap.
- Check before discharging:
 1. Ensure that the battery capacity of the vehicle to be discharged is not below 15%.
 2. Ensure the VTOL connecting device casing is not cracked, and its plug is free from rust or obstructions.
 3. Ensure that there is no water or foreign material inside the charge port and that metal terminals are not damaged and free from rust or corrosion.
- Do not discharge if any of the above conditions is found; otherwise, short circuit or electric shock so caused could lead to personal injury.
- Connect the discharge connection device:
 - Connect the VTOL discharging connector to the charge port and confirm that it is connected in place.
- After the switch button* on the discharging socket is pressed, the socket indicator stays on (red), indicating that the socket can be used.
- Discharging starts:
 - After the connection is made, discharge begins and respective information is displayed on the instrument cluster.

Stopping discharging

- Stop discharging:
 - Disconnect the load.

- Disconnect the discharge connection device:
 - With the vehicle unlocked, pull the discharging connector out of the charge port.
 - Close the charge port cap and the port door (see **P80**).
- Organizing the equipment:
 - Store the equipment properly when discharging is complete.

Charge Port Anti-theft Lock

- In order to prevent the charging connector from being stolen, the vehicle charge port is anti-theft during charging and discharging. The anti-theft function is deactivated by default. To enable the function, go to the the Infotainment touchscreen  → New energy → Charge Settings and then tap Activate.
- Tap "Activate" or "Deactivate" in Charging port anti-theft lock.
- When the mode of charging port anti-theft lock is activated, the charging connector will lock if the user connects the charging connector and the four doors, hood and trunk lid are locked. To disconnect the connector, the user needs to unlock the vehicle.

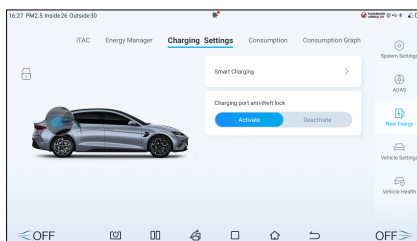

Unlocking

- When the function is enabled, unlock the vehicle and unplug the charging connector during charging in the following ways:
 - When it is on OFF status, press the unlock button on the smart key to unlock.
 - Press the microswitch next to the exterior handle of the driver's side door to unlock.
 - Press the central unlock button on the driver's side door to unlock.

No.	Charge Port Anti-theft Lock Status	Door Anti-theft Lock Status	Charging Connector Removable or Not
1	Activate	Locking	No
2	Activate	Unlocking	Yes
3	Deactivate	Locking	Yes
4	Deactivate	Unlocking	Yes

WARNING

- The connector needs to be pulled out within 30s after the charge port electric lock is unlocked. Otherwise, the electric lock will lock again.

Emergency Unlocking of the Charge Port

- When the electric lock fails and the charging connector cannot be unplugged, try to unplug the charging connector by manually unlocking the charge port.

Charge port lock dragline

1. Open the trunk. There is an emergency cable for the charging connector on the right side panel inside the trunk.
2. Unlock the charging connector by unlocking the emergency cable latch and pulling the emergency cable.
3. Reset the emergency cable latch after the unlocking is completed.

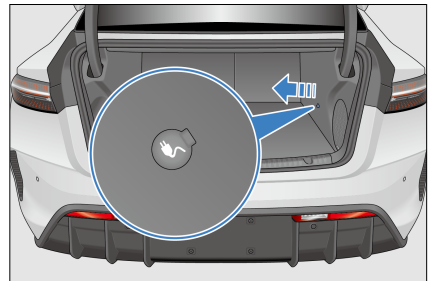

REMINDER

- If the above functions are abnormal or fail, contact a BYD authorized dealer or service provider.

Driving Range Display

The "Driving Range Display Mode" can be set to improve driving experience. The default setting is "Standard". You can personalize it by Infotainment touchscreen  → New energy → Energy management.

- Standard mode: displays the driving range based on the result of comprehensive working condition test.

- Dynamic mode: displays the estimated driving range based on the available battery power and current average energy consumption.
- The set driving range display mode is memorized by the system. When the vehicle is powered off and then on, the display mode set last time will be maintained.

REMINDER

- When the Dynamic range display mode is set:
 - The driving range that is displayed after a full charge may vary, depending on calculations of the energy consumed the last time the vehicle is used.
 - The displayed driving range is adjusted based on whether the A/C is on, selection of driving mode, and the driver's driving habits, so that this range can be closer to the estimated remaining range under current use.

Energy Regeneration Settings

Energy regeneration: In this process, the motor will generate reverse torque when the vehicle is decelerating, and the generated energy will be recovered and reused to improve the energy utilization rate of the vehicle.

- Braking regeneration:
 - When the vehicle is running in D position, if you completely release the accelerator pedal and depress the brake pedal, and the vehicle is in a stable state, priority is given to responding to motor regeneration for deceleration during braking and deceleration. When the motor capacity is insufficient, the hydraulic brake will actively intervene to maintain the deceleration demand of the vehicle, and the generated energy will be recovered to improve the vehicle economy.
- Sliding regeneration:
 - When the vehicle is running in D position, if you release the accelerator pedal at a certain depth, the motor will output reverse torque to decelerate the vehicle, and the generated energy will be recovered to improve the vehicle economy.
- During driving, energy is recovered through regenerative brakes when the vehicle decelerates. For higher efficiency, do not accelerate or decelerate the vehicle unnecessarily.
- The energy regeneration intensity can be set with the regenerative mode button or on the infotainment touchscreen.
 - Standard: When the accelerator pedal is released, the motor controller recovers energy in the standard level, and the vehicle deceleration is in the standard level.
 - High: When the accelerator pedal is released, the motor controller recovers more energy, and the vehicle deceleration is high.
- The corresponding settings can be made in infotainment system →  → New Energy → Energy Management → Energy Regeneration Mode.
- You can select the regeneration intensity based on the deceleration sense when releasing the accelerator pedal. Different deceleration senses deliver different driving experiences.
- The set energy regeneration intensity will be memorized. When the vehicle

is powered off and then on, the regenerative braking mode set last time will be maintained.

REMINDER

- Do not set the regeneration intensity when driving the vehicle in high speed, as the driver may be distracted. This may obstruct the control of the vehicle, resulting in accidents.

Battery

High-Voltage Battery

- The vehicle is powered by a high-voltage battery that can be charged and discharged repeatedly. The high-voltage battery is charged by an external power source or through energy recovery when the vehicle brakes or coasts.
- The high-voltage battery is located under the vehicle floor, so be careful and slow down to avoid bumping when driving on bumpy or uneven roads. If bumping occurs, go to a BYD authorized dealer or service provider for maintenance.

Battery Properties

- It is normal that vehicle performance is affected by battery electrochemical properties and self-protection and varies to some extent in the following conditions:
 - When SOC is high, the regenerative braking performance may decline.
 - The vehicle switches to trickle charging mode at high SOC. If the charging time is prolonged, the estimated remaining charging time

displayed on the instrument cluster may not be accurate.

- When SOC is low, the acceleration performance may decline.
- When the high-voltage battery is low, VTOL* cannot be used as normal. Charge the battery promptly.
- At high or low temperatures, it is normal that the charging and discharging capabilities of the high-voltage battery decline, and the charging time is prolonged. Power performance may also decline under extreme temperatures.
- For charging at low temperatures, the temperature control system can significantly improve the charging capability. For details regarding low-temperature charging, see Charging Precautions.
- When the vehicle is used at low temperatures, the battery's temperature control system will start heating the battery as appropriate to ensure the driving power and discharging performance and improve your driving experience. When the vehicle is driven over short distances, heating may be ineffective, which increases power consumption and decreases driving range.
- When the high-voltage battery is normal, the driving range of the vehicle varies with the following factors:
 - Driving habit: For example, the range in frequent acceleration or deceleration is shorter than that at constant speeds, and the range is shorter when driving at high speeds than when at low speeds.
 - Road conditions: For example, the range driven in rough conditions or on long slopes is shorter than that in normal conditions and on even roads.

- Air temperature: The driving range at low temperatures is shorter than that at ambient temperatures.
- Use of electric equipment: For example, the range driven with A/C on is shorter than that with A/C off.
- Usable capacity of the high-voltage battery is lower in cold weather and reduces as the temperature decreases. If the vehicle with high battery level is charged at low temperatures, the SOC may quickly jump to 100%.
- The available battery capacity decreases as the vehicle is used over time.

Usage Tips

- It is recommended to use the vehicle at temperatures between -10°C to 40°C. When SOC is low, timely charge the vehicle to ensure enough driving range and good acceleration performance.
- To maintain long-term performance, avoid continuously exposing the vehicle to high temperatures or extremely low temperature environments for over 24 hours.
- In low ambient temperatures, if the vehicle must be stored for a long time, it can be placed in an underground garage or other warmer area to reduce loss of battery heat, maintaining vehicle performance.
- Frequent and sudden acceleration or deceleration should be avoided. Drive the vehicle on flat and dry roads. When necessary, turn off high-power equipment such as A/C or adjust the A/C temperature to reduce power consumption of such devices and increase the driving range.
- When the vehicle is used for the first time or after a long idle period, the

SOC displayed on the cluster may not be correct. It is recommended to fully charge the vehicle first.

- During daily use, please fully charge the vehicle on a regular basis (at least once a week), and fully charge it from a low battery level (<10% SOC) once every three to six months.
- Under extreme working conditions (such as frequent sudden acceleration/ deceleration) that cause battery overheating, if the temperature of high-voltage battery is excessively high, it is normal that discharging capability will gradually decrease. If the battery temperature keeps rising, the fault light on the cluster will light up. At this time, it is recommended to contact a BYD authorized dealer or service provider.
- When the battery SOC increases or decreases abnormally, it is recommended to contact a BYD authorized dealer or service provider for inspection.

WARNING

- In the event of an emergency or accident, be aware of the following warnings:
 - To avoid personal injury, do not touch the power battery directly.
 - Please contact a BYD authorized dealer or service provider as soon as possible.
 - If the high-voltage battery is damaged and leaking fluid, avoid any contact with the fluid. If it comes into contact with skin or eyes, rinse immediately with plenty of water, and seek immediate medical attention.
 - If the vehicle catches fire, use dedicated fire extinguishers

 **WARNING**

instead of water-based fire extinguishers.

 **CAUTION**

- To ensure safety of the high-voltage battery, stop the vehicle away from flammable and explosive materials, ignition sources and various hazardous chemicals.
- The available battery capacity will decrease as the vehicle is used over time.
- Prolonged exposure to heat sources and direct sunlight will reduce high-voltage battery service life.
- When the vehicle is not to be operated for an extended period (over 7 days), it is recommended that the battery SOC should be kept at 40%-60% to prolong its service life. When the vehicle is not to be operated for over 3 months, the power battery must be fully charged and then discharged to 40%-60% every 3 months. Otherwise, over-discharge may result, leading to battery performance degradation or even damage. Any vehicle fault or damage so caused will not be covered by the quality warranty.
- As the power battery is arranged at the bottom of the vehicle, careful driving is recommended in case of bumpy roads. If there is a collision with the high-voltage battery, contact a BYD authorized dealer or service provider immediately for maintenance.

 **CAUTION**

- No one is allowed to enter the vehicle when the battery pack needs to be repaired.

High-Voltage Battery Recycling

How to scrap an NEV:

1. Take the vehicle to the BYD recycling service provider that will assess the residual value of the high-voltage battery.
2. Take the assessed vehicle to the recycling organization to disassemble the high-voltage battery.
3. Take the battery to the recycling service provider which will buy back the battery.

 **WARNING**

- New energy car owners have the responsibility and obligation to hand over waste high-voltage batteries to the recycling service outlet. Anyone who hands over a used high-voltage battery to any other organization or individual, or removes/disassembles a high-voltage battery without authorization, shall be liable for any environmental pollution or safety incident so caused.

Low-Voltage Battery

The low-voltage (12V battery) is located under the rear left seat.

- Battery working modes include "Normal", "Sleep", "Ultra-low Power", "Low-Voltage Protection", etc. The purpose is to protect the battery cell from damage. If the vehicle system is in good condition, the vehicle switches

between these modes automatically, having no effect on your use of the vehicle.

- To avoid low-voltage battery feed, the smart charging function will be actively triggered if conditions (hood closed, ignition "OFF", high-voltage battery discharging allowed, and low-voltage battery level lower than the design value) are met.
- When the smart charging function is triggered, the low-voltage battery is charged through the high-voltage battery. Therefore, it is normal that the SOC or the pure-electric driving range displayed on the cluster decreases, when the vehicle is started after being idle.
- If "smart charging" fails, the low-voltage battery may cut off the vehicle's power supply. If you find before use that the vehicle is not powered, try to activate the low-voltage battery by pressing the driver door microswitch continuously, and immediately power on the vehicle to charge the low-voltage battery. It is recommended to charge it for more than 1 hour.

CAUTION

- The starter iron battery contains relays. Thus it is normal to hear a "click" sound when the battery is running.
- The starter iron battery shall be charged with professional charging tools, and shall not be removed for recharging without permission.
- Do not jump-start the vehicle with another fuel vehicle, as this may damage the starter iron battery.
- The starter iron battery is a battery on low-pressure platform

CAUTION

that is different from an ordinary lead-acid battery. Please read the instructions for use in this manual in detail.

- The starter iron battery has a built-in power manager. Do not disassemble or repair the battery without permission to avoid damaging the battery or causing personal injury.
- The starter iron battery needs to communicate with the vehicle for normal use, so it is important to connect its connector and wiring harness correctly.

Usage Precautions

Break-in Period

- If the powertrain is hard to start or frequently stops turning, inspect the vehicle immediately.
- If the powertrain makes any abnormal sounds, stop the vehicle for inspection.
- If the powertrain has severe coolant and oil leakage, stop the vehicle for inspection.
- The powertrain needs break-in. It is recommended that this be done within the first 2,000 km in economic mode by smoothly driving, instead of high-speed driving. The following practices can effectively prolong vehicle service life:
 - Avoid flooring the accelerator pedal when starting and driving the vehicle.
 - Do not maintain a high or low speed for too long.

- Avoid speeding.
- Do not use the vehicle to tow other vehicles within the first 2,000 km of mileage.

Trailer Towing

- This vehicle is designed to carry passengers. Do not overload it or use it to tow other vehicles.
- Towing other vehicles will have an adverse impact on the vehicle, including maneuverability, performance, braking, endurance, economic driving or power consumption.
- Driving safety and comfort totally depend on equipment usage and good driving habits.
- BYD does not provide free warranty for the damage or faults resulted from towing for commercial purposes.

REMINDER

- Do not tow a trailer whose weight exceeds the hook capacity. Otherwise, it may cause an accident, resulting in serious personal injury.
- Be sure to increase the distance between the vehicle and another ahead of it when towing a trailer as the braking distance may be increased in towing. When driving at 10 km/h, keep this distance at least equal to the sum of the length of the vehicle and the trailer. Avoid emergency braking to prevent vehicle folding and out of control due to slippage.
- Maintain the trailer's tire pressure at the value specified by the trailer manufacturer based on the gross weight of the trailer.

REMINDER

- If the vehicle is used to tow a trailer, improve the maintenance frequency due to vehicle load increase.

Driving Safety Precautions

No driving after drink

Drinking even a small amount of alcohol reduces your ability to adapt to road traffic conditions. Drinking more alcohol further slows your responses. Therefore, never drive while under the influence.

Speed control

Speeding is a major cause of collisions involving injury and death. In general, faster speeds entail higher risk. Therefore, please maintain a driving speed safe for the traffic conditions on the road.

Maintaining the vehicle in safe driving condition

Tire bursts and mechanical faults are extremely dangerous. To reduce the possibility of such faults, frequently check the vehicle's condition, and regularly complete the specified inspections.

CAUTION

- Any driver must possess a driver's license before driving a vehicle.
- Do not drive when fatigued.
- Always follow the traffic regulations when driving a vehicle.
- When driving, drivers must stay focused and not carry out any unrelated activity, such as



CAUTION

answering calls or adjusting buttons.

Suggestions for Vehicle Use

Suggestions for prolong the battery life:

- When the vehicle is not to be operated for an extended period (over seven days), it is recommended that the battery SOC should be kept at 40%-60%, or it will reduce high-voltage battery service life.
- When the vehicle is not to be operated for over three months, the high-voltage battery must be fully charged and then discharged to 40%-60%. Otherwise, over-discharge may lead to battery performance degradation or even damage. Any vehicle fault or damage so caused will not be warranted.
- During operation of the vehicle, if the instrument cluster displays the pure electric driving mileage as 0, it indicates the battery SOC is low. In this case, charge the high-voltage battery in time and avoid operating the vehicle with low SOC for a long time.
- For optimal battery performance, use a charging connector to fully charge the battery regularly, and the recommended frequency is once a week at least.
- To maintain long-term performance, avoid continuously exposing the vehicle to an environment with a temperature above 60°C or below -30°C for over 24 hours.
- If the tray dented inward or there is scarification under the battery package tray, it is suggested to check

at a BYD authorized dealer or service provider.

- During operation of the vehicle, avoid repeated rapid acceleration or deceleration whenever possible.
- During operation of the vehicle, avoid operating the vehicle continuously for a long time whenever possible; otherwise, the excessively high battery temperature will affect vehicle performance.
- If the instrument cluster malfunctions when driving, it is recommended to contact a BYD authorized dealer or service provider for inspection as soon as possible.
- When the high-voltage battery temperature is high, the vehicle performance will be limited to some extent. In this case, stop the vehicle and wait until the temperature drops before operating.



REMINDER

- If the meter drops to 0, the battery must be recharged. If it is not recharged within 7 days, the battery may suffer permanent damage. Such damage is not covered by BYD warranty terms.
- Driving range depends on many factors, such as the vehicle's available power, vehicle age (current battery life), weather, temperature, road conditions and driving habits. Compared with under normal temperatures, the pure-electric driving range is somewhat reduced and power performance will also be affected in low or high temperature environments.

Saving Energy and Extending Vehicle Service Life

- Saving energy is simple and easy, and it helps prolong the vehicle's service life.
- Energy and repair cost saving precautions:

1. Regenerative braking setting:

- This vehicle can regenerate energy and the regenerating degree can be set by Infotainment touchscreen



→ Vehicle Settings → Energy

management. When regenerative braking is set to high, energy recovery increases when braking and coasting. Set this feature according to your driving habits.

2. Maintaining constant speed:

- Constant speeds save energy. Sudden acceleration, sharp turns and emergency braking increase consumption.
- Speeds should be kept constant according to traffic conditions. Additional energy is consumed each time the accelerator is pushed.
- Acceleration should be gradual. Avoid sudden startup, acceleration, or deceleration.
- Prevent emergency braking and subsequent brake wear by keeping an appropriate distance from vehicles ahead and paying attention to traffic lights.
- Congested roads increase energy consumption.
- Keep moderate speeds in motorways. The higher the speed, the higher the consumption. Maintaining vehicle

speed within the economical speed range can save power.

3. Reduce load:

- Energy consumption is higher when air conditioning is used. Turn off the A/C to reduce power consumption. When outside temperatures are moderate, use fresh air mode.
- Do not overload the vehicle unnecessarily. Excessive weights add the load of vehicle, increasing energy consumption.

4. Other tips:

- Ensure tires are properly inflated. Low tire pressure increases energy consumption and wear.
- Keep front wheels properly aligned, avoid driving into curbstones, and drive slowly in rough terrain. Misalignment of the front wheels not only increases tire wear, but also increases load on the powertrain and power consumption.
- Keep the bottom of the vehicle clean and mud free. This reduces vehicle weight and prevents corrosion.

WARNING

- Do not coast in neutral gear.

Carrying Luggage

- This vehicle has multiple storage spaces that allow you to conveniently keep items. Overloading or improper accommodation may affect maneuverability, stability and normal operation of the vehicle, and reduce its safety.
- The glove box, storage boxes on interior trim panels and file pockets on seat backs are designed for small and

light objects, while the trunk for large and heavy objects.

- The vehicle's total load (vehicle + passengers + luggage) is not allowed to exceed the maximum allowable mass.

WARNING

- Overloading and improper accommodation may affect stability and vehicle control, which may lead to accidents.
- Observe the maximum weight limit and other loading guidelines in this manual.
- Do not carry highly magnetic items, for those might interfere in the the vehicle's operating functions.

Carrying Items in the Passenger Area

- All items that could be thrown inwards and thus injure occupants in case of a collision must be properly placed and secured.
- Do not place any objects on the inner side of rear windscreen. Otherwise, these objects will block the driver's line of sight and will be thrown here and there inside the vehicle in case of collision.
- Ensure that items placed on the floor behind the front seat do not roll under the seat, so as to avoid affecting the driver's ability to control the pedals or normal seat adjustment. Do not stack items to a height taller than the front seats' seat backs.
- Make sure the glove box is always closed while driving. If the glove box is open, the occupant's knees may be injured in case of a collision or an emergency stop.

REMINDER

- Be careful with children's toys inside the cabin, for these may pose a hazard in case of emergency braking or accidents.

Loading the Trunk

- Place luggage evenly in the trunk. Put heavier items at the bottom and as far in as possible.
- Secure items with ropes or straps so that they will not move while driving. Do not stack items to a height taller than seat backs.

Wading into Water

- Check water depth - it must not exceed the vehicle's lower edge before driving into flooded areas.
- If crossing a flooded area is necessary, turn off the air conditioner and keep acceleration steady to slowly cross over.

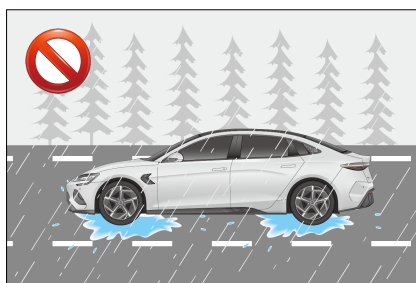

- Never stop, back up, or turn off the vehicle in flooded areas.
- Be careful when driving through deep water, as brakes may get wet. After crossing over, press the brake pedal several times to dry out the disks and recover brake performance.

WARNING

- Drive carefully to avoid accident when there is any water or slurry on the brake disc surface, as this may increase the brake response time thus extending the braking distance.
- Carefully apply any wet brake, and remove ice or water on it.
- Avoid emergency braking as far as possible after driving through any waterlogged road section.
- If the vehicle drives on the waterlogged road, prevent water from entering the motor, otherwise the motor will be damaged seriously. Such damaged is not covered by the vehicle's warranty
- After the vehicle drives through waterlogged road sections, vehicle components, such as drive system, driving system and automotive electric system may also be damaged seriously. Such damage is not covered by the vehicle's warranty either.
- Be sure to find a sheltered place when charging the vehicle on rainy days. If the vehicle is immersed in water or wades through water over the doorsill, which may cause water ingress in high-voltage components, promptly contact a BYD authorized dealer or service provider for testing and troubleshooting.
- Do not drive the vehicle on the road where the depth of accumulated water exceeds half of the tires.

Influence of water ingress in high-voltage components:

- Water getting into high-voltage components, which are electronic devices, may not be fully dried out by any means.
- Water ingress seriously compromises insulation of high-voltage components, and conductive substances in water may lead to short circuit of high-voltage components or such risk in the entire high-voltage system. This significantly affects the safety and service performance of the vehicle.
- The reduced ingress protection rating and voltage withstanding performance due to water in high-voltage components pose a high safety risk.

Fire Prevention

To prevent vehicle fires in a timely and effective manner, pay attention to the following during use of the vehicle:

- No flammable or explosive items are allowed in the vehicle.
 - Temperatures may reach 60-70°C in a vehicle exposed to direct sunlight in summer. Therefore, flammable and explosive items, such as lighters, cleaning agents and perfumes, stored in the vehicle can cause a fire or even explosion easily.
- Make sure cigarettes are thoroughly put out.
 - Smoking is harmful to your health and may cause a fire. Cigarettes that not thoroughly put out may cause a fire.
- It is recommended to go to a BYD authorized dealer or service provider for regular vehicle checks.
 - Check vehicle wiring, connections, wiring harnesses, insulation, and

- fixed position regularly. Deal with identified problems promptly.
- Do not refit vehicle wiring or add any unauthorized electrical appliance.
 - The addition of extra electrical appliances, such as high-power audio systems, and light fixtures, may overload and overheat the wiring harness and increase the risk of fire.
 - Improper refitting of electrical appliances or wiring may cause a fire due to contact resistance and abnormal heating. Fuses or other replacement wires in excess of relevant electrical rating are strictly prohibited.
 - Select a proper parking location.
 - When parking the vehicle, try to avoid sun exposure.
 - When the vehicle is parked, especially in summer, do check whether there are any flammables such as dry grasses, dead woods, leaves or wheat straws under the vehicle. If any, a fire may be caused.
 - When the vehicle is running, avoid driving on the road sections piled up with flammables such as dry leaves, wheat straws and grasses, or immediately stop the vehicle to check whether any flammables are carried along after passing such road sections.
 - Keep a lightweight fire extinguisher in the vehicle and know how to use it.
 - In order to ensure vehicle safety, a fire extinguisher should be equipped in the vehicle, and be checked and replaced regularly. Also, you should familiarize yourself with use of the fire extinguisher and be prepared for any accidents.
 - Disconnect the negative cable of the low-voltage battery when the vehicle is being serviced or repaired.
 - In the event of a fire in the vehicle, take effective measures in a timely and calm manner to minimize any losses:
 - Fires typically show initial warning signs, such as abnormal noises and odors in the vehicle body. When abnormal conditions are found, turn off and stop the vehicle immediately. It is best to park the vehicle in a windproof place, and then put out the fire using the fire extinguisher in the vehicle.
 - Call the fire alarm in time, and also dial the insurance company's reporting number and ask the company to come to the fire site for handling.
 - Look for the ignition point. If the engine compartment smokes, do not open the hood immediately. (This will let a large amount of air in and cause fire spreading. There is limited comburent in the cabin. Keeping the hood closed can control the fire so that the fire can be easily put out). Point the on-board fire extinguisher at the ignition point from the hood gap to put the fire out, or seek help from the passing cars. If you can borrow more fire extinguishers, open the hood to put it out when you cannot see any flame from outside.
 - If the fire brigade is involved, ask for a duty performance certificate and a description of fire cause.
 - After occurrence of the accident, contact the insurance company for post-event handling in a timely manner.

! REMINDER

- In order to mitigate losses in the event of an accident, the purchase of commercial insurance (fire loss, theft, etc.) is recommended.

Snow Chains

- Snow chains are only for emergencies or areas where they are permitted by laws.
- Snow chains should be installed on rear wheels. Be careful when driving the vehicle installed with snow chains on snow-covered roads. Use thin snow chains that provide enough space for the tires and other parts in the hubcap, for some snow chains may damage tires, wheels, suspensions, and the vehicle body.
- Read the component assembly drawings and other instructions provided by the snow chain manufacturer carefully.
- Before purchasing and installing snow chains, consult a BYD authorized dealer or service provider where your vehicle was purchased.
- After snow chains are installed, be sure to travel at a speed below 30 km/h on snow-covered roads.
- In order to minimize wear of tires and snow chains, do not travel with snow chains on roads without snow.

! REMINDER

- Do not drive at speed above 30 km/h or maintain a speed lower than the speed limit specified by the snow chain manufacturer.
- Drive carefully, paying attention to bumps, potholes, and sharp

! REMINDER

- turns that can cause the vehicle to bounce.
- For vehicles with snow chains, avoid sharp turns or braking with locked wheels, and slow down the vehicle before entering a curve to avoid accidents due to loss of control.
- Tires snow chains should be used symmetrically and removed immediately when not in use.

Starting and Driving

Starting the Vehicle

Preparations Before Driving

- Check the surroundings before getting into the vehicle.
- Adjust seat position, seat back angle, cushion height, headrest height, and the steering wheel angle and height.
- Adjust interior rearview mirror and side mirrors.
- Close all doors.
- Fasten the seat belts.

Safety Check Before Driving

It is advisable to carry out a safety check before driving long distance, which may ensure your driving safety and enhance your driving experience. The vehicle can also be taken to a BYD authorized dealer or service provider for inspection.

Exterior

- **Tires:** Check tire pressure and carefully inspect tires for any cut, damage, foreign material, anomaly, and excessive wear.
- **Lug nuts:** Ensure all nuts are fitted and tightened.
- **Lighting:** Make sure headlights, position lights, turn signals and all other lights are working normally. Check headlight intensity.

Interior

- **Seat belts:** Check whether seat belts can be properly fastened. Verify that seat belts are not worn or scratched.
- **Instrument cluster:** Particularly, verify that maintenance indicator, instrument cluster lighting, and defroster work properly.
- **Release the brake pedal:** Verify that there is enough space for the brake pedal to work.
- **Low-voltage battery and cable:** Inspect connectors for any corrosion or looseness and any cracks in low-voltage battery housing.

In the engine compartment

- **Spare fuses:** Verify that spare fuses of all rated charges in the fuse box are available.
- **Coolant level:** Verify that coolant level is correct.

Check after starting

- **Instrument cluster:** Confirm that the maintenance indicator and the speedometer work normally.
- **Brakes:** In a safe area, drive the vehicle straight, hold the steering wheel tightly, decelerate and apply the brake. Verify that the vehicle maintains a straight direction.
- **Other abnormalities:** Check for loose parts, leaks, and unusual noises.

If everything is OK, just enjoy your driving.

Starting the Vehicle

Starting the vehicle in normal cases:

- Carry a valid smart key with you, depress the brake pedal ② and press the START/STOP button ① at the same time, and then the OK indicator on the instrument cluster illuminates, indicating that the vehicle is ready for driving.
- Shift to "D" or "R" position, and then the electrical parking brake will be released automatically. Do not start driving the vehicle until hearing a motor release sound from the electrical parking brake system.

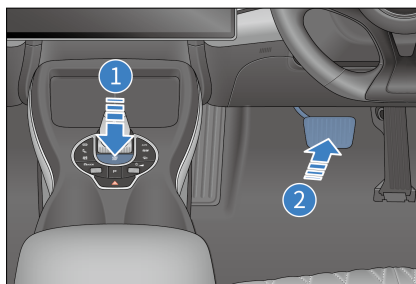

The vehicle cannot power on when

- The vehicle cannot power on when:
 - After you press the START button, the smart key warning light turns on, a beep sounds, and the message "No key detected" is displayed on the instrument cluster. This means that the key is not in the vehicle or cannot be detected due to interference.
 - The key is somewhere unsuitable for detection, such as on the floor, in the cup holder, trunk, etc.
 - Pressing the START button may not enable the start function due to:

- If the electronic smart key does not work, the smart key system warning indicator on the combination instrument flashes, and the message "Low key battery" is displayed on the information display screen in the middle of the combination instrument, indicating that the key battery may have run out. Replace the electronic smart key battery as soon as possible with reference to the operation procedure given in "Smart Key Battery Runs Out".
- Except for causes mentioned above, the PEPS system also fails to work normally under some conditions due to different service environments. See "Smart Access and Start System" for relevant details.

Starting the vehicle in emergencies

- Engage the parking brake firmly.
- Turn off all unnecessary lights and accessories.
- The gearshift lever is on "P".
- Switch the ignition off.
- The electronic smart key is in the vehicle.
- Press and hold the smart key start button for over 15 seconds.

Check after starting

- Instrument cluster: Confirm that the maintenance indicator and the speedometer work normally.
- Brakes: In a safe area, verify that the vehicle maintains a straight direction.
- Other abnormalities: Check for loose parts, leaks, and unusual noises.

If everything is OK, just enjoy your driving.

Remote Start*

Remote Start with the Electronic Smart Key

1. Press and hold the remote start/stop button on the electronic smart key for two seconds to start the vehicle. Turn signals will flash three times after it is started.
2. If there is no valid operation within 10 minutes after remote start, the vehicle stops and powers off, and turn signals flash twice.



3. Press and hold the remote start/stop button on the electronic smart key for two seconds. The vehicle stops and powers off, and turn signals flash twice.

Gear Shift Controls

- The gear position of the gear actuator is marked on the gearshift lever.
- "P" gear is for parking, press this button to park the vehicle and the parking indicator will light up. Press the brake pedal to start the vehicle, you may shift from "P" to another position.

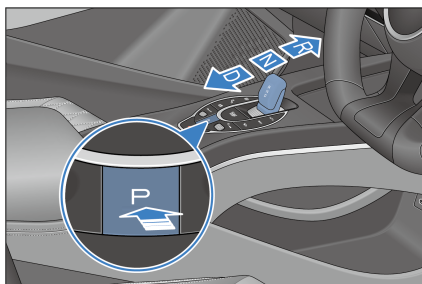

CAUTION

- To avoid injury, press the "P" button only after the vehicle has completely stopped.
- "R": Reverse, used only when the vehicle has come to a complete stop.
- "N": Neutral, used for temporary stop. Under all circumstances, always shift to "P" before the driver gets out.
- "D": Drive, shift to D position to drive the vehicle normally.
- If the shift is successful, the lever returns to its middle position after it is released.
- Turn the ignition on in "OK" button before shifting into "D".
- Shifting out of "P" or into "D" gear requires pressing the brake pedal. For details, see the prompt message on the instrument cluster.

WARNING

- If the motor is turned off and the vehicle travels for a long time after it is in the "N" gear, the transmission may be severely damaged due to lack of lubrication.
- When the motor is running and the vehicle is in the "R"/"D" gear, always stop the vehicle by stepping on the brake pedal, as

WARNING

there is still force transmitted from the actuator and the vehicle can travel slowly even in its idle condition.

- If you want to shift a gear while driving forward, do not step on the accelerator pedal to prevent accidents.
- Never shift to "R" or press the "P" button while the vehicle is moving, in order to prevent accidents.
- Never coast downhill in "N" or "P", even if the motor is not running.
- To prevent unintended vehicle movement, pull up the brake and press the "P" button once the vehicle has stopped completely.

Electronic Parking Brake (EPB)*

Be sure to engage the EPB every time before parking and leaving the vehicle.

Engaging EPB Manually

Set EPB on the "EPB" option on infotainment touchscreen, when you press the brake pedal and EPB is released, EPB applies an appropriate parking force, the indicator on the instrument cluster flashes and then is steady on, indicating that EPB is engaged. In addition, a text prompt "EPB activated" is displayed.

CAUTION

- When (P) flashes, EPB is working. If the vehicle is on a slope, do not release the brake pedal until (P) is



CAUTION

steady on. Otherwise the vehicle may move down.

Automatic EPB Engagement

Automatic EPB engagement

- When the vehicle is powered off, EPB automatically engages and the (P) indicator lights up on the cluster.

Automatic "P" gear engagement

- Press the brake pedal to stop the vehicle and engage P gear. EPB is engaged automatically. Do not release the brake pedal until the indicator on the cluster stops flashing and become steady on and the "EPB engaged" message is displayed.



CAUTION

- After the trailer mode for EPB is enabled via the infotainment system, EPB will be not activated automatically when the vehicle is in "P" mode or powered off. This function may be used for towing or pushing the vehicle after the vehicle breaks down.
- Do not release the brake pedal early in the process, especially when the vehicle is stopped on a slope; otherwise, there will be a risk of vehicle sliding to slight extent.
- This function is designed to improve the vehicle safety. Excessive reliance on or frequent use of the function is not recommended. To ensure safety, make sure that the transmission is shifted to "P" before getting off.

Automatic EPB Release upon Vehicle Start

- With the vehicle parked, start the vehicle, press and hold the brake pedal, and shift the gear from "P" or "N" into a driving gear like "D" or "R". EPB is released automatically, the indicator turns off, and a "EPB released" message is displayed.



CAUTION

- Please follow the correct shift instructions and keep depressing the brake pedal throughout the shifting process. Do not release the brake pedal until the gear position shown on the instrument cluster is the target one.
- Within several seconds after the vehicle is started, the EPB system will conduct self-check upon power-up. In this process, the EPB will not respond to any function.
- When the vehicle has been started and the gear is in a driving gear like "D" or "R", engage EPB manually, then simply press the accelerator pedal slowly to a certain degree. EPB is released automatically and the (P) indicator turns off with the message "EPB Released" displayed.

Emergency Braking When Brake Pedal Fails

- If braking fails or is blocked, continue to press p gear switch or pull the EPB switch* for emergency braking.





CAUTION

- For safety considerations, refrain from using the EPB for braking in normal driving. If the brake pedal fails or is blocked, use the

 **CAUTION**

emergency braking function while you can always keep the vehicle under control and drive normally.

EPB System Indicator

- When the vehicle is powered on, if the EPB is engaged,  is solid on on the instrument cluster.
- When the vehicle is powered off, if the EPB is engaged,  on the instrument cluster turns on and then turns off in several seconds.
- When the vehicle is powered on, the EPB system starts self-check. The indicator  on the instrument cluster turns on and then turns off in several seconds. If it does not, the EPB or braking system may be faulty. It is recommended to contact a BYD authorized dealer or service provider for inspection as soon as possible.

EPB Operating Sound

- EPB motor noises can be heard while the EPB is being engaged or released.
- After the emergency braking function is activated, if there is a burning smell or unusual noises are heard, contact a BYD authorized dealer or service provider immediately.

 **WARNING**

- To prevent sliding down, do not park the vehicle with the gearshift mechanism instead of EPB before leaving the vehicle. Be sure to use the EPB got parking and ensure that the transmission is shifted to "P".

 **WARNING**

- To prevent a serious accident, never allow any passenger in the vehicle to operate the EPB switch when the vehicle is running.
- When the EPB is pulled up or released, depress the brake pedal as far as possible to prevent vehicle sliding and the resulting gear shifting jamming when the EPB cannot output enough parking force.
- For safety considerations, refrain from using EPB for braking in normal driving. It is preferred to be used when the brake pedal fails or is blocked.
- As the EPB cannot go beyond the physical limit of road adhesion, activating the emergency brake function may result in vehicle drift, sideslip or deflection when the vehicle passes through bends or dangerous/heavy-traffic road sections, or when the vehicle is driven under severe weather conditions. Be careful and do not cause any accident.

Automatic Vehicle Hold (AVH)

The automatic vehicle hold (AVH) takes place when the vehicle needs to be stationary for longer periods of time, such as in traffic jams on a slope or waiting at traffic lights. When the AVH standby preconditions are met, AVH is activated if you press the brake pedal until the vehicle stops.

- Press the AVH switch to enable AVH. A white AVH standby indicator is displayed on the instrument cluster

and will turn green when AVH can be enabled.

- Press the AVH switch again to disable AVH.

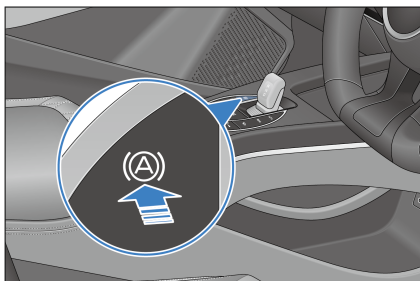

CAUTION

- Pressing the accelerator pedal, switching to the "P" gear, or engaging the EPB can make the vehicle exit AVH mode and return to the AVH standby status; even if the AVH standby status conditions are not met, the vehicle will also exit AVH mode.

Preconditions for AVH Standby (All Must Be Met)

- AVH switch is turned on and the white AVH standby indicator is displayed on the instrument cluster.
- The driver seat belt is fastened and the doors are closed.
- The vehicle drive motor is started or the ignition is on.
- Intelligent power braking system and electrical park brake (EPB) systems are normal.

AVH Running Conditions (All Must Be Met)

- The AVH function is standby.

- In D gear, the brake pedal is pressed to stop the vehicle.
 - The AVH function is enabled, brake lights and the high mounted stop lamp are on, and the AVH indicator on the cluster turns green.
 - The AVH function enters the standby mode after working for 10 minutes, with the EPB automatically engaged.

CAUTION

- For AVH to be activated, all the conditions must be met at the same time.
- For AVH to be activated, all conditions of automatic parking function must be met.
- When the gear is shifted from D to R, the system will enter the moving mode, and the AVH function will not be activated. When the AVH button is pressed or the speed exceeds 10 km/h, the system will exit the moving mode.

Driving Precautions

- Slow down when driving against strong winds.
- Drive slowly and carefully along gravel roads. To prevent tire damage, do not drive over sharp-edged obstacles. Or it will severely damage the tires.
- Slow down on bumpy or uneven roads or the shock would damage the tires.
- Avoid driving through flooded areas as much as possible.
- Drive carefully on slippery roads, such as roads covered in ice, snow or sand, or surfaces such as wet ceramic tiles or epoxy resin. Avoid parking on slopes to prevent vehicle sliding.

REMINDER

- The battery is located in the vehicle's chassis. Make sure to avoid bumping when driving.
- Before driving, make sure that EPB is fully released and that the EPB indicator light is off.
- Do not leave the vehicle when the drive motor is running.
- Do not put foot on the brake pedal when driving. Otherwise, this will cause overheating, wear and waste of electric energy.
- Slow down when driving down steep slopes, and avoid braking too frequently to prevent disc overheating, which affects brake performance.
- Be careful when accelerating or braking on slippery roads. Quick acceleration or sudden braking will cause the vehicle to skid or deviate.
- Make sure no occupant sticks their head or hands outside the vehicle, specially when it comes to children.
- Large amounts of water entering the engine compartment can cause damage to the power system and electrical components.

WARNING

- The driver shall ensure the riding safety of all passengers in the vehicle, guide them to correctly use vehicle features, and prevent children and other passengers operating control switches such

WARNING

as window switches in a wrong way.

Winter Driving Precautions

- Make sure the coolant is freeze-proof.
 - Use coolant of the same type as the one used originally. Fill up coolant into the cooling system based on ambient temperature.
 - Improper coolant will damage the cooling system.
- Check batteries and cables conditions.
 - The low-voltage battery's capacity is lower in cold weather, so they must be fully charged when winter comes.
- Avoid door frost.
 - Spray some deicing agent or glycerin in the lock hole to prevent freezing.
- Use anti-freeze washer fluid.
 - These can be found in the BYD authorized dealer or service provider and the auto parts stores.
 - The water and anti-freeze ratio must conform to manufacturer instructions.

CAUTION

- Do not use other substitutes as washing fluid, which may damage the vehicle paint.
- Prevent ice and snow from going under the fender.
 - Steering is difficult with ice or snow accumulating under the fenders. When driving in cold weather, stop from time to time and check for snow and ice under the fenders.

- It is recommended to carry emergency tools or items for different road conditions.
 - It is advisable to have snow chains, window scraper, bags of sand and salt, flashing signal, a shovel and connecting cables in the vehicle.



Driver Assistance

Adaptive Cruise Control (ACC)

- The adaptive cruise control (ACC) system, an extension of the traditional cruise control, uses a radar and a multifunctional video controller to detect the relative distance and speed of the vehicle ahead, so as to control vehicle speed accordingly. The system switches between regular cruise control and ACC according to whether there is a vehicle ahead.
- Cruise speed and time interval from the vehicle ahead can be set by using the cruise buttons. Cruise control speed can be set within a 30 to 150 km/h (20~95mph) range, or a fixed distance from the vehicle ahead can be set to cruise at speeds between 0 and 150 km/h (0~95mph).

Status Description

- ACC standby:
 - Once enabled, the system is on standby by default and can be manually activated. If the vehicle does not meet activation conditions, it must be checked until such conditions are met. At this time,  is displayed on the instrument cluster. (The cruise speed value is variable.)

- ACC activated:
 - The system is operational. It maintains the set speed or automatically adjusts the distance from the vehicle ahead. At this time,  is displayed on the instrument cluster. (The cruise speed value is variable.)
- Over speed:
 - When you step the accelerator pedal while ACC is active, the vehicle responds to your acceleration action so that the ACC is temporarily deactivated until you release the pedal.
- ACC failure:
 - There has been a failure in the system. No operation can be performed, and the ACC failure indicator  is displayed on the instrument cluster. (The cruise speed value is variable.)

ACC Activation Conditions

- The EPB has been released.
- The vehicle is in Drive.
- The vehicle does not slide backwards.
- The trunk, hood, and all doors are closed.
- Driver seat belt is fastened.
- The ESC system is on, but not activated yet.
- The vehicle speed is not greater than 150 km/h (95 mph).
- Brake pedal is pressed at speed 0; or brake pedal is not pressed at speeds above 0.

- There is no vehicle network communication failure prompt on the instrument cluster.
- The AEB function is not activated.

Cruise Button Operation

ACC on/off button

Press button ① to activate or exit ACC. (The system is in standby when activation conditions are met). (By default, ACC activation by pressing button ① sets the current speed as the cruise speed. If the current speed is below 30 km/h, the cruise speed is set to 30 km/h.)

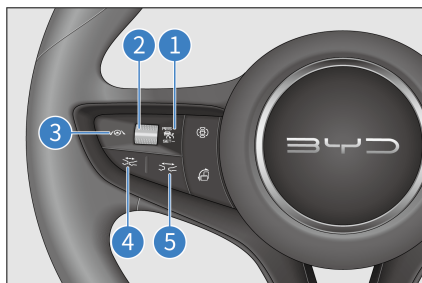

Resetting ACC

When the ACC system is on standby within the same ignition cycle, the system memorizes the last speed setting. Push up the lever ② to restore to the stored speed prior to exiting the cruise system.

Increasing/Decreasing target speed

When ACC is active, set the vehicle to a speed within the 30~150 km/h range by moving the lever ②. Toggling the lever ② up or down each time increases or decreases target speed by 5 km/h.

Exiting ACC

While ACC is active, pressing button ① again or pressing the brake pedal makes the ACC system go on standby.

WARNING

- Please strictly abide by the speed limit regulations of local roads, control the speed and drive safely. Do not overspeed.

Setting vehicle distance

- The driver must select a safe vehicle distance.
- The system adjusts vehicle speed to keep a suitable distance from the vehicle ahead on the same lane. Pressing buttons ④ and ⑤ on the steering wheel adjusts vehicle distance to any of the four available levels. At each level, vehicle distance is in direct proportion to vehicle speed. The faster the speed, the longer the distance.

Increasing/Decreasing speed with ACC active

- When ACC is activated, you can press the accelerator pedal to reach the set target cruise speed in advance. The system then enters over speed mode. At the target cruise speed, if you accelerate without performing any other operations, the vehicle accelerates and then returns to target cruise speed after the accelerator pedal is released.
- When you press the brake pedal with ACC activated to slow down the vehicle, ACC goes into standby mode. After the brake is released, ACC needs to be reactivated.

Follow-to-stop/start

- Controlled by ACC, the vehicle can stop when the vehicle ahead stops in normal driving conditions and resume driving automatically following the vehicle ahead if the stop is less than 30 seconds.
- If the vehicle stops for 30 seconds to three minutes, press the accelerator

pedal or pushing up lever ② to reactivate ACC.

System Limitations

- The front mmWave radars are installed in the front of the vehicle. Blockage of its detection area by contaminants can disturb the intended function. In particular, if the sensor is covered by snow completely, the ACC system exits and informs of this on the instrument cluster. System function will recover after blockage is removed and the vehicle is restarted or runs on normal roads for a while.
- Front mmWave radar sensors may have a transient function failure from limited detection if the vehicle runs under special conditions, such as circular ramps or tunnels, for an extended period. The function can be recovered by restarting the vehicle or driving on normal roads for a while.
- Reaching or leaving a curve may delay or disturb target selection. In such cases, the ACC vehicle may not brake as expected or may brake late.
- On roads with sharp curves, such as winding roads, the vehicle ahead may be out of ACC sensor detection for several seconds due to sensor vision limitations, possibly causing the ACC vehicle to accelerate automatically.
- Traffic flow and weather conditions, such as rain and fog, must be heeded for setting vehicle distance on the ACC system. After the ACC system is properly set, the driver must be able to decelerate until the vehicle stops at any time.
- The ACC system may not be able to identify stationary or slow-moving objects, such as vehicles, the end of traffic, toll booths, bicycles, or pedestrians. This means a risk of

collision and requires the driver to beware of the surroundings.

- The ACC system cannot identify pedestrians or oncoming vehicles.
- The ACC system can only achieve limited braking instead of emergency braking.
- Metal objects, such as rail or metal plates used in road construction, may interfere with front mmWave radars, making it malfunction.
- Performance of front mmWave radar sensors may be affected by vibration or collision. In this case, it is recommended to contact a BYD authorized dealer or service provider.
- ACC cannot be activated in special driving modes like tow/snow/mud/sand/terrain (if equipped with these modes).

Precautions

- ACC is a comfort system rather than a safety system, obstacle detector or collision warning system. The driver must keep control of vehicle at all times and be fully responsible for the vehicle.
- ACC assists instead of replacing the role of the driver. The driver is responsible for abiding by traffic rules and keeping vehicle control.
- For safety reasons, ACC cannot be activated with ESC disabled.
- The ACC is suitable for highways and roads in good conditions, rather than complex urban or meandering roads.
- It is the driver's responsibility to keep distance from the vehicle ahead. The ACC system's vehicle distance meets the minimum distance required in driving environments in the country.

- Vehicle control is transferred to the driver if the accelerator or brake pedal is pressed with ACC active. As a result, the ACC system cannot keep a safe distance from the vehicle ahead.
 - ACC may have no or slow responses to a vehicle ahead that brakes or stops suddenly, resulting in a risk of late braking. In such cases, there will be no take-over request.
 - In some cases, such as when the vehicle ahead is going too slow, when lane change is too fast, or when the safe distance from the vehicle ahead is too short, there is no adequate time for the system to decrease the relative speed, so response has to come from the driver. The system cannot give audio or visual warnings in every case.
 - If ACC is activated with the vehicle stationary, the system identifies any stationary obstacle ahead and keeps the vehicle still to ensure a safe startup and prevent collision. However, this function does not cover all obstacles, so the driver must be alert.
 - A short distance from an adjacent lane (or a vehicle on an adjacent lane that is too close to the ACC vehicle's lane) may trigger ACC to brake.
 - Vehicles coming into the ACC vehicle's lane and within the detection range of its front mmWave radars are identified as target vehicles and prompt a response accordingly, which may lead to hard or late braking.
 - Detection may be affected or delayed in some environments. If the radar reflection cross-sectional area of the target (a bicycle, four-wheeler, or pedestrian, for example) is too small, the system may not be able to establish its distance, resulting in either late or no response to those vehicles. In such cases, vehicle speed must be controlled by the driver.
- In addition, detection may also be affected or delayed by noise or electromagnetic interference.
- ACC cannot target vehicles with too small contact ratio, so the driver must keep control of the vehicle.
 - When the vehicle stops as it follows a vehicle ahead, in rare cases, the system does not recognize the end of the vehicle ahead but the lower end of the target (for example, the rear axle of a truck with a high chassis or a vehicle bumper). In such cases, the system cannot ensure proper stop distance, so the driver must stay alert and be ready to brake.
 - If ACC is activated with the vehicle stationary, the system identifies any stationary obstacle ahead and keeps the vehicle still to ensure a safe startup and prevent collision. However, this function does not cover all obstacles, so the driver must be alert.
 - Modifying the vehicle structure, such as lowering the chassis or changing the front license mounting plate may affect the ACC system.
 - Do not use the ACC system when visibility is poor, or when driving on slopes, winding roads, or wet roads (covered in ice/snow or flooded).
 - Make sure to go to a BYD authorized dealer or service provider for professional calibration and checking of front mmWave radars or the multifunctional video controller in any of the following situations:
 - The front mmWave radar, front bumper, or front windshield has been removed.
 - Wheel alignment has been carried out.
 - The vehicle has experienced a collision.

- ACC system performance has degraded or the instrument cluster has prompted a system error.

WARNING



- ACC only serves as a driving assistance function, so the driver must be fully responsible for driving safety.
- Influence of weather, road conditions, and other factors may cause ACC to fail.
- Use ACC based on your needs, traffic, and road conditions.

Intelligent Cruise Control (ICC)

- The intelligent cruise control (ICC) system integrates ACC and lane centering control (LCC). It helps control the vehicle both longitudinally and transversely at speeds between 0 km/h and 120 km/h to reduce the driving burden and provide a safe and comfortable driving environment.
- When the function is enabled, the driver must always hold the steering wheel and control the vehicle when necessary.
- Longitudinal assistance, driven by the ACC system, keeps the vehicle at a fixed speed or a fixed distance from the road user ahead.

Status Description

- ICC standby: The ICC system is on standby by default and can be manually activated. If the vehicle does not meet activation conditions, the vehicle must be checked until such conditions are met. At this time,  is displayed on the instrument cluster.

- ICC activated: The ICC system is operational. It maintains the set speed or automatically adjusts the distance from the vehicle ahead. At this time,  is displayed on the instrument cluster.
- ICC failure: There has been a failure in the system. No operation can be performed, and the ICC fault indicator  is displayed on the cluster.

ICC Activation Conditions

- The EPB has been released.
- The vehicle is in Drive.
- The vehicle does not slide backwards.
- The trunk, hood, and all doors are closed.
- Driver seat belt is fastened.
- The ESC system is on, but not activated yet.
- Vehicle speed is not greater than 120 km/h.
- Brake pedal is pressed at speed 0; or brake pedal is not pressed at speeds above 0.
- There is no vehicle network communication failure prompt on the instrument cluster.
- The AEB function is not activated.
- Two-way lane lines are clear and the vehicle is at the center of the lane.

How to Use

- Press the button  on the steering wheel to activate or exit ICC. (By default, when the function is activated, the current speed is set as the cruise speed. If the current speed is below

30 km/h, the cruise speed is set to 30 km/h.)

- For how to set the cruise speed and vehicle distance, see ACC function descriptions (in the previous chapter).

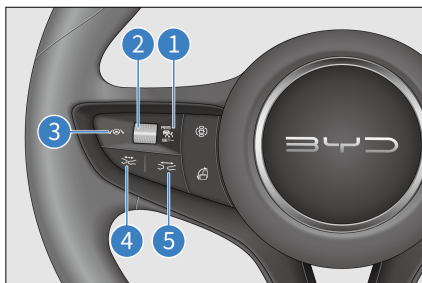

- You can also turn ICC on or off in Vehicle Settings  → ADAS → Intelligent Driving. When the vehicle is just started up, ICC status before the last power-off is maintained.

Precautions

- ICC integrates ACC and LCC. Therefore, ACC function precautions must be followed during use (see the previous chapters for details).
- When ICC is turned on and activated at vehicle speeds between 0 km/h and 120 km/h:
 - If there is no lane lines ahead, transverse ICC control is suppressed and only ACC works. In that case, ICC working status indicator turns gray on the instrument cluster.
 - If lane lines ahead are clear and recognizable, transverse ICC control is activated automatically. In that case, ICC working status indicator shows activated status on the instrument cluster.
- The ICC system is a driving assistance system, not an automatic driving system. The driver should keep control of vehicle at all times, and their hands

should not leave the steering wheel for a long time. Otherwise, the system will exit after prompting the driver to take over the control.

- The ICC system can be affected by weather conditions, lighting and clarity of lane lines. Performance degrades significantly in situations such as backlighting, sunset, snow covered roads, and severely damaged roads.
- Do not use the ICC system on winding roads with sharp turns, icy and slippery bends, or under weather conditions, such as dense fog, heavy rain and heavy snow, liable to hinder the sensing operation of front mmWave radars or the multi-purpose camera.
- Situations where ICC cannot be used include:
 - The sensor is blocked.
 - The vehicle is running under severe weather conditions.
 - Active safety function is triggered.
 - Vehicle speed exceeds specified range.
- ACC cannot be activated in special driving modes like tow/snow/mud/sand/terrain (if equipped with these modes).







WARNING

- ICC serves as a driver assistance function only, so the driver must be fully responsible for driving safety.
- Influence of weather, road conditions, and other factors may cause ICC to fail.
- Use ICC based on your needs, traffic, and road conditions.

Predictive Collision Warning (PCW) & Automatic Emergency Braking (AEB)

Predictive collision warning (PCW) system and automatic emergency braking (AEB) system detect vehicles and pedestrians ahead by using a radar and a multi-purpose camera. When detecting a risk of collision, the system gives audible and visual alarms to alert the driver and improves the potential braking pressure for better response timing. If detecting increased risk of collision, the system automatically applies braking pressure to assist in collision avoidance or impact reduction.

How to Use

- Enable or disable the PCW and AEB in  → **ADAS** → **Active Safety**.
- PCW gives alarms in forms of audio, messages, and intermittent braking.
- When PCW is activated,  or  flashes, depending on the level of emergency, and a prompt message is displayed on the instrument cluster.
- When AEB is triggered,  flashes together with a prompt message on the instrument cluster.
- In the event of malfunction,  is displayed on the instrument cluster.
- If you disable AEB manually by pressing buttons,  is displayed on the instrument cluster.

PCW Activation Conditions

- This function has been turned on in **Vehicle Settings**.
- Vehicle speed is within the 16 km/h-150 km/h.

- The vehicle is in Drive.
- The vehicle does not slide backwards.

AEB Activation Conditions

- This function has been turned on in **Vehicle Settings**.
- Vehicle speed is within the 4 km/h-150 km/h.
- The EPB has been released.
- The vehicle is in Drive.
- The vehicle does not slide backwards.
- The trunk, hood, and all doors are closed.
- Driver seat belt is fastened.
- The ESC system is on, but not activated yet.

System Limitations

- Detection may be affected or delayed in some environments. If the radar cross section of the target (a bicycle, three-wheelers, four-wheeler, or motorized bicycle, or motorcycle, for example) is too small, the system may not be able to establish its distance, resulting in either late or no response to those vehicles. In such cases, vehicle speed and distance must be controlled by the driver.
- The system may be affected or give no response in the following cases:
 - On rainy, snowy or foggy days, large water splashes, or exposure to direct sunlight or glaring lights, or significantly varying lighting conditions.
 - Dirty, hazy, damaged or blocked sensor.
 - Radar failure due to interference from other radar sources, such as

strong radar reflection in multi-storey car park.

- In complex traffic, the system may be unable to properly respond to the following circumstances:
 - Pedestrians or vehicles move too quickly into the sensor's detection range.
 - Pedestrians are obscured by other objects.
 - Pedestrian outlines are indistinguishable from the surroundings.
 - Pedestrians are not detected, due to, for example, coverage by special clothing or other materials.
- The vehicle is on a sharp curve.

Precautions

- The AEB system cannot ensure zero collision. In complex traffic, the system cannot always clearly identify all the vehicles or pedestrians. It may trigger unnecessary warning or braking action for well covers, iron plates or road signs.
 - Make sure to drive safely and observe surrounding traffic conditions. The AEB is not a substitute for normal braking operation in any event.
 - Do not overly rely on the AEB system as this may result in severe injuries or deaths. The system is only an auxiliary safety tool. The driver must always keep a safe distance from vehicles ahead, control the speed, and be ready to brake or steer away when necessary. The driver must keep control of vehicle at all times and be fully responsible for safe driving.
 - The AEB system is activated only when it exceeds certain speeds. Careful driving is always required, because the system may not be triggered correctly.
- The AEB system cannot work normally when the ESC function is disabled or the fault light is on.
 - If PCW gives an alarm, the driver must brake based on traffic conditions to decrease vehicle speed or steer away from obstacles.
 - If the vehicle travels too close to the vehicle ahead for too long, a safety distance warning will be given. If the vehicle ahead brakes suddenly, collision may be unavoidable.
 - The system will not trigger AEB when the driver is aware of an emergency warning, such as turning the steering wheel, pressing the throttle pedal hard or braking hard.
 - Front mmWave radar sensors may have a transient function failure from limited detection if the vehicle runs under special conditions, such as circular ramps or tunnels, for an extended period. The function can be recovered by restarting the vehicle or driving on normal roads for a while.
 - Sometimes the front mmWave radar or multifunctional video controller detect dirt or foreign matter on its surface, then PCW and AEB would malfunction, you need to clean the dirt or foreign matter immediately.
 - As the pedestrian protection function is limited by certain physical conditions, the driver must take timely and effective control of the vehicle under dangerous conditions.
 - The system cannot completely protect pedestrians or avoid accidents and severe injuries on its own.
 - Under certain complex conditions, the pedestrian protection function may trigger unnecessary warning or braking. For example, on the curving main lane.

- System failure may trigger wrong warnings or braking. This may be caused, for example, by the misalignment of the front mmWave radar or multi-purpose camera.
- The brake pedal becomes harder if AEB is triggered. A large amount of hydraulic pressure will be required to push the caliper in a short time and there will be a sizzling noise.
- The AEB system activates only after all doors are closed and all occupants are buckled up. Note: The AEB system will fail to work if:
 - Any door is not closed or it is opened when the vehicle is moving.
 - Any seat belt has not been fastened or it is unfastened while the vehicle is traveling.
 - The driver accelerates or decelerates rapidly or turns the steering wheel quickly.
 - The vehicle is on a sharp curve.
- System performance may be reduced in the following cases:
 - Strong front bumper impact from accidents or other causes.
 - Improperly inflated or worn out tires.
 - Unqualified tires installed.
 - Snow chains installed.
 - Use of a small spare tire or tire repair kit.
- Make sure to go to a BYD authorized dealer or service provider for professional calibration of the medium-range front mmWave radar and multifunctional video controller in any of the following situations:
 - The front mmWave radar or multi-purpose camera has been removed.
 - Toe-in or rear camber has been adjusted during wheel alignment.
 - The position of front mmWave radars or the multi-purpose camera has changed after a collision.
- Do not attempt to test the PEB system on your own using objects such as carton, iron plate, dummy, etc. The system may not work properly and thus result in accidents.



WARNING

- PCW and AEB serve as driver assistance functions only, so the driver is fully responsible for driving safety.
- Influence of weather, road conditions, and other factors may cause PCW and AEB to fail.
- Use PCW and AEB based on your needs, traffic, and road conditions.

Front Cross Traffic Alert (FCTA)/Front Cross Traffic Braking (FCTB)

Front cross traffic alert (FCTA) and front cross traffic braking (FCTB) detects vehicles crossing the driveway at the front through mmWave radars on both sides of the front bumper to alert the driver and engage the brake if necessary. At low vehicle speeds, when the system detects a risk of collision with a vehicle crossing the driveway at the front, it provides the driver with visual and audible alerts; in the event of an impending collision, the vehicle brakes automatically.

How to Use

- To enable or disable the FCTA and FCTB, go to Infotainment touchscreen , and tap ADAS → Active Safety.
- When front cross traffic alert (FCTA) is activated, the rearview indicator flashes and a chime sounds.
- When FCTB is activated,  is displayed on the instrument cluster and a chime sounds, with AEB automatically braking the vehicle.
- In the event of FCTA/FCTB malfunction,  is displayed on the instrument cluster.

Precautions

- While the system provides assistance in monitoring front left and right sides, it cannot replace the driver's observation and judgment. The driver must keep control of vehicle at all times and drive properly and is fully responsible for the vehicle.
- When a target vehicle is approaching from the side at a high speed, the FCTA/FCTB system may not be able to provide adequate warning.
- The driver must ensure the normal operation of the system, keeping mmWave radars on both side of the bumper in good condition. For example, dirt, snow, or other obstructions need to be cleared right away.
- In addition, detection may also be affected or delayed by noise or electromagnetic interference.
- Under some circumstances, it is difficult for the system to assist the driver, and detection may be affected or delayed. Possible circumstances include, but are not limited to:

- The vehicle coming from the side changes the lane suddenly.
- The target vehicle is obscured.
- The radar cross section of the target vehicle (for example, a bicycle or electric moped) is too small.
- Severe weather, such as rain or snow.
- MmWave radar(s) come off, are loosely installed, or are blocked.
- The vehicle encounters complex metal guardrails or similar road conditions.
- The system does not work when:
 - Targets are outside the mmWave radar's detection range.
 - FCTA or FCTB is switched off.
 - The vehicle is not in Drive.
 - Four doors are open.
 - System initialization has not been complete yet.
 - MmWave radar(s) fail.
 - Vehicles coming from the front left or right side are detected too late at sharp turns, slopes, or other settings.
- Influence of vibration or collision on mmWave radar sensor calibration can degrade system performance. If this is detected, contact a BYD authorized dealer or service provider.

WARNING

- FCTA/FCTB serves as a driver assistance function only, so the driver must be fully responsible for driving safety.
- Influence of weather, road conditions, and other factors may cause FCTA/FCTB to fail or lead to late braking.







WARNING



- Use FCTA/FCTB based on your needs, traffic, and road conditions.

Traffic Sign Recognition (TSR)

The traffic sign recognition (TSR) system identifies speed limit signs through the multi-purpose camera and map*, displays such signs on the current road on the instrument cluster, and sends alarm messages to the driver when vehicle speed exceeds the detected limit.

How to Use

- Enable or disable TSR in Vehicle Settings  → ADAS → Driving Assist.
- When the TSR system identifies the current traffic sign,  is displayed on the instrument cluster.
- When TSR cannot identify whether the recognized speed limit value applies to the lane,  is displayed on the instrument cluster.
- When the TSR system experiences reduced performance,  is displayed on the instrument cluster.
- When the TSR system has a reduced performance and cannot identify whether the recognized speed limit value applies to the lane,  is displayed on the instrument cluster.
- If the TSR system malfunctions,  is displayed on the cluster.

- If you disable TSR manually by pressing buttons,  is displayed on the instrument cluster.
- The specific numbers displayed in the indicators depend on the actual traffic signs.
- When no available speed limit value is identified,  is displayed on the instrument cluster.

Precautions

- The traffic sign recognition system can identify speed limit signs only, and will not control speed. The control over the vehicle always vests in the driver. Please drive properly.
- Weight limit signs not in standard size as per national regulations may mistakenly be identified as speed limit signs.
- If a speed limit sign is unclear, distorted, inclined, reflective, or partly blocked or overlaid, the multi-purpose camera may fail to or incorrectly identify the sign.
- TSR performance depends on weather conditions, lighting, and sign visibility. The system may fail to or incorrectly identify the sign at night or sunset, in rainy, foggy, hazy, snowy or dusty environment, when light is coming from the back of the vehicle, or when there is a sudden change in lighting.
- In case the vehicle has been involved in a collision or the multi-purpose camera's sensor has been reassembled, go to a BYD authorized dealer or service provider for sensor calibration so as to avoid affecting system performance.
- If the model is available in the European market, recognition of traffic jams, construction zones, and accidents ahead must rely on Internet

connection, provided that the system supports the recognition of these signs. It is recommended to use the function under Wi-Fi or hotspot connection. You can also use mobile data on the infotainment system as long as it is within the monthly data limit.

WARNING

- TSR serves as a driver assistance function only, so the driver must be fully responsible for driving safety.
- Influence of weather, road conditions, and other factors may cause TSR to fail or lead to late alarms.
- Use TSR based on your needs, traffic, and road conditions.

Intelligent Speed Limit Control (ISLC)

- The Intelligent Speed Limit Control (ISLC) system integrates ACC and TSR. With the system enabled, if the vehicle travels faster than the detected speed limit, a confirmation prompt is displayed asking whether to set cruise speed to that limit. After the driver confirms, the system will automatically set cruise speed to the limit to prevent speeding. After the driver confirms (roll down ② ACC speed control lever), the system will automatically set cruise speed to the limit to prevent speeding.

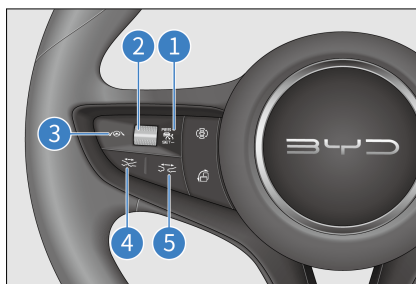

- This function is accessible at the 30-150 km/h speed range.

How to Use

- Enable or disable ISLC in  → **ADAS** → **Driving Assist** → **TSR** → **ISLC**.
- When the TSR system is disabled, the ISLC switch is grayed out and unusable. ISLC is turned off at this time. The ISLC switch will be usable after the TSR system is enabled again.
- ISLC can be activated provided that ACC is active.

CAUTION

- The Intelligent Speed Limit Control (ISLC) system integrates the Adaptive Cruise Control (ACC) and Traffic Sign Recognition (TSR) functions. Therefore, ACC and TSR function precautions should be followed during use (see the previous chapter for details).
- ISLC is a driver assistance system, so the driver must keep control of the vehicle at all times.
- ISLC performance depends on weather conditions, lighting, and traffic sign visibility. The system may fail to or incorrectly identify the sign at night or sunset, in rain, fog, haze, snow or dust, when light is coming from the back of



CAUTION

the vehicle, or when there is a sudden change in lighting.





WARNING

- ISLC only serves as a driving assistance function, so the driver must be fully responsible for driving safety.
- Influence of weather, road conditions, and other factors may cause ISLC to fail or lead to late alarms.
- Use ISLC based on your needs, traffic, and road conditions.

High Beam Assist (HMA)

The high beam assist (HMA) system automatically activates or deactivates the high beam based on current driving conditions assessed by using sensors of the multifunctional video controller, when vehicle speed exceeds 35 km/h.

Status Description

- HMA standby: When the function is enabled but not activated yet,  is displayed on the instrument cluster.
- HMA activated: With the function enabled, when you set the light switch to the auto lights position, the light meets conditions, and vehicle speed exceeds 35 km/h,  is displayed on the instrument cluster.
- HMA failure: HMA has failed.  is displayed on the instrument cluster at this time.

How to Use

- To enable or disable HMA, go to infotainment touchscreen , and tap ADAS → Driving Assist. When the vehicle is started, the system defaults to the previous settings.
- With the function enabled, the light switch is on Auto and the vehicle speed is over 35 km/h, the system automatically switches between low and high beams based on the current driving environment.

Precautions

- The HMA system is an auxiliary light control function. While it is recommended to use the system at high vehicle speeds, the system cannot completely replace the driver. The driver must observe road regulations and actively switch between high and low beams according to road condition changes at all times.
- When the vehicle is in a high dynamic state such as in ABS or ESC, beam switching may be inactive.
- HMA system exits when fog light and turn signal are turned on, wipers are set to high-speed mode, the vehicle is backing up, light switch is not on Auto, and the surrounding light is too strong.
- Even when HMA is working, the driver must respond to possible situations where the HMA is triggered in error or fails to work due to unavoidable environmental factors and conditions. Typical situations are:
 - The driver's stick operation to switch to the high beam is prioritized.
 - The weather, such as fog, rain or snow, is extremely terrible for driving.

- There are traffic participants with poor lighting (such as pedestrians and bicycles), railways or waterways nearby, or wild animals on the roads.
- There are strongly reflective objects around, such as traffic signs on highways and water reflection on the road surface.
- The front windshield is dirty, covered in mist, or blocked by stickers or decorations.
- In case there is a collision or the sensor has been reassembled, it is recommended to go to a BYD authorized dealer or service provider for sensor calibration so as to avoid affecting system performance.

WARNING

- HMA serves as a driver assistance function only, so the driver must be fully responsible for driving safety.
- Influence of weather, road conditions, and other factors may cause HMA to fail.
- Use HMA based on your needs, traffic, and road conditions.

Lane Departure Assist (LDA)



Lane Departure Warning (LDW)

The lane departure warning (LDW) system detects the lane lines ahead through a multi-purpose camera. When the vehicle speed is 60 - 150 km/h and the driver unintentionally drifts out of the lane, the LDW system warns the driver by steering wheel vibration, sound alarm and instrument cluster prompt.

Lane Departure Prevention (LDP)*

- The lane departure prevention (LDP) system identifies lane lines ahead through a multi-purpose camera. If the driver unknowingly departs from the lane at a vehicle speed between 60 km/h and 150 km/h such that the vehicle is about to roll over lane lines, the system, when activated, slightly turns the steering wheel by providing reverse torque through the electronic power steering (EPS) system to prevent lane departure.
- If LDP system is activated for over five seconds, it gives visual and audible alarms at the fifth second and continues until this activation ends. If the system is activated twice or more within a continued 180-second cycle, the system alarms. For the third intervention (and any further ones), alarms are extended by at least 12 seconds.

Usage

- To enable or disable LDA, go to infotainment touchscreen →  → **ADAS** → **Driving Assist** → **Lane Assist System**.
- There are three LDW modes: audible alarm only, steering wheel vibration only, and combination.
- When LDW or LDP is enabled,  is displayed on the instrument cluster.
- When activated, LDW gives alarms (in the form of audible alarm, visual alarm, and steering wheel vibration). On the instrument cluster, virtual lane lines on the side where the vehicle rolls over lane lines turn red.
- When activated, LDP gives alarms (in the form of audible and visible alarms). On the instrument cluster,  flashes twice, virtual lane lines on the side

where the vehicle rolls over lane lines turn blue.

- In the event of malfunction,  is displayed.

System Limitations

In a complex road traffic environment, the LDA system may detect the lane line incorrectly or fail to detect the lane line.

In the following cases, the system may not work or its performance may be significantly degraded:

- Poor visibility on snowy, rainy, or foggy days
- Dirty or fogged windshield, or blocked multi-purpose camera.
- Glaring from direct sunlight, reflection, or oncoming vehicles
- Sudden changes in light, such as when the vehicle is entering or exiting a tunnel
- Lane lines obscured by tree shadows on roads in direct sunlight on sunny days
- Unidentifiable road boundary with grass, soil, or curb

Precautions

- LDW will be suppressed if a turn signal is used and the vehicle changes lane as indicated by the turn signal.
- LDW may be suppressed if the vehicle travels over lane lines or if lane lines are unclear, too thin, worn, blurred, or covered by dirt/snow.
- LDW may be suppressed if the lane is too wide or too narrow, if the number of lanes increases or decreases, if lane markings change suddenly on ramps or exits, or in situations of complex line arrangements.

- LDW may be suppressed on slopes or winding roads when the vehicle travels too close to the vehicle ahead or when the vehicle ahead obscures lane lines.
- LDW may be suppressed when the vehicle jolts, accelerates or decelerates too quickly, or takes a sharp turn.
- The system operation may be affected if the windshield within the visual field of the multi-purpose camera is cracked, if the front windshield glass is dyed or coated in a manner that is not compliant with standards, if any reflective object is placed on the dashboard, or if any other object interferes with camera sight.
- For safety reasons, do not test LDW function on your own. The function will be interrupted if the multi-purpose camera is blocked by any object or exposed to strong lights. The function recovers once conditions return to normal. If it does not, it is recommended to contact a BYD authorized dealer or service provider.
- Disabling the LDW is recommended under any of the following circumstances:
 - Driving in a sporty style
 - Severe weather conditions
 - On uneven roads
- Situations where lane lines may not be identified include, but are not limited to:
 - Unclear lane lines
 - Incomplete lane lines
- Situations that may cause recognition difficulty or late function activation of the multi-purpose camera include, but are not limited to:
 - The multi-purpose camera comes off, is loosely installed, or is blocked.

- The vehicle is running under extreme weather, such as rain, snow, or smog.
- The multi-purpose camera is partially or completely blocked.







WARNING

- LDA serves as a driver assistance function only, so the driver must be fully responsible for driving safety.
- Influence of weather, road conditions, and other factors may cause LDA to fail.
- Use LDA based on your needs, traffic, and road conditions.

Emergency Lane Keeping Assist (ELKA)

The emergency lane keeping assist (ELKA) system identifies lane lines ahead through a multi-purpose camera and identifies vehicles approaching from behind on the adjacent lanes through rear corner mmWave radars. It comes to work within the 50 km/h-150 km/h vehicle speed range when the vehicle drifts out of solid lane lines, is about to cross a road edge, or has a risk of colliding with oncoming vehicles or vehicles that are passing it on adjacent lines. The system activates EPS system to provide reverse torque, keeping the vehicle in the current lane.

How to Use

- Enable or disable this function in  → **ADAS** → **Driving Assist** → **Lane Support System (LSS)**.
- When ELKA is active,   flashes on the instrument cluster.
- In the event of ELKA malfunction,   is displayed.
- If you disable ELKA manually by pressing buttons,  is displayed.

System Limitations

- The ELKA system may detect incorrect or no lane lines in complex traffic. The following situations may lead to failure or performance degradation of the system:
 - Poor visibility on snowy, rainy, or foggy days
 - Dirty or fogged windshield, or blocked multi-purpose camera
 - Glaring from direct sunlight, reflection, or oncoming vehicles
 - Sudden changes in light, such as when the vehicle is entering or exiting a tunnel
 - Lane lines obscured by tree shadows on roads in direct sunlight on sunny days
 - Unidentifiable road boundary with grass, soil, or curb

Precautions

- Situations where lane lines may not be identified include, but are not limited to:
 - Pedestrians, animals, and specialty or specially-shaped vehicles
 - Unclear or incomplete lane lines
- Situations that may result in detection failure of the multi-purpose camera or late alarms include, but are not limited to:
 - The multi-purpose camera comes off, is loosely installed, or is blocked.
 - The vehicle is running under extreme weather, such as rain, snow, or smog.
 - The multi-purpose camera is partially or completely blocked.

- Situations that may result in detection failure of mmWave radars or late alarms include, but are not limited to:
 - MmWave radar(s) come off, are loosely installed, or are blocked.
 - The vehicle is running under extreme weather, such as rain, snow, or smog.
 - The vehicle encounters certain metal guardrails or similar road conditions.

WARNING

- ELKA serves as a driving assistance function only, so the driver is fully responsible for driving safety.
- Influence of weather, road conditions, and other factors may cause ELKA to fail.
- Use ELKA based on your needs, traffic, and road conditions.

Blind Spot Assist (BSA)

- The blind spot assist (BSA) system includes blind spot detection (BSD), rear cross traffic alert (RCTA), rear cross traffic braking (RCTB), rear collision warning (RCW), and door open warning (DOW). It detects environment behind the vehicle through radars installed on both sides of the rear bumper so as to remind the driver of safe driving.

Blind Spot Detection (BSD)

At vehicle speeds between 15-150 km/h, if a rear corner mmWave radar detects a vehicle in blind spots on an adjacent lane or a vehicle approaching quickly on the adjacent lane, the indicator on the corresponding side mirror lights up. If the turn signal for the same side is turned on at this moment, the alarm indicator on

the side mirror flashes to alert the driver of a risky lane change.



Rear Cross Traffic Alert (RCTA)

When the vehicle is reversing at a speed no more than 15 km/h, the RCTA system detects the vehicles traveling in the blind spot at the back through rear corner mmWave radars. If the system judges that a vehicle approaching from behind poses a risk of collision, the side mirror warning indicators flash and an audible alarm is given to alert the driver, reducing the possibility of collision.

Rear Cross Traffic Braking (RCTB)

When the vehicle is reversing at a speed no more than 9 km/h, the RCTB system detects the vehicles traveling in the blind spot at the back through rear corner mmWave radars. If the system determines that a vehicle approaching from behind poses a risk of collision, it performs emergency braking automatically.

Rear Collisions Warning (RCW)

At vehicle speeds between 5 km/h and 146 km/h, if the rear corner mmWave radar detects a risk of collision with a vehicle approaching quickly from behind on the current lane, the hazard warning light turns on to warn the driver in that vehicle against a possible collision.

Door Open Warning (DOW)



DOW is realized with rear corner mmWave radars installed on both sides of the rear bumper. When the vehicle is stationary

with doors unlocked, the system keeps indicators on side mirrors solid on to warn the driver if moving objects, such as bicycles or automobiles, approach from behind on an adjacent lane. If the driver attempts to open the door at this time, indicators on side mirrors begin to flash and a chime sounds.

Function Button Operation

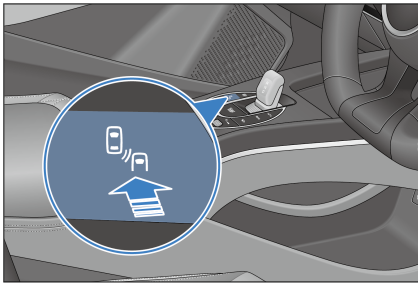
- To enable or disable BSD, RCTA, RCTB, RCW and DOW, go to Infotainment touchscreen  → ADAS → Active Safety → Blind Spot Assist. When the vehicle is started, the system defaults to previous settings.



- When the blind spot assist system is disabled, no relevant indicators are displayed on the instrument cluster.
- When the blind spot assist system is standing by, if vehicle conditions, such as speed or gear status, do not meet the requirements of any function,  is displayed on the instrument cluster and blind spot assist will not be activated.
- If the blind spot assist system malfunctions,  is displayed on the instrument cluster.
- When the blind spot assist system is active,  is displayed on the instrument cluster, meaning that the function has been activated and can trigger alarms at any time.

Precautions

- While the BSD system provides assistance in monitoring blind spots of rearview mirrors, it cannot replace the driver's observation and judgment. The driver must keep control of vehicle at all times and drive properly and is fully responsible for the vehicle.
- The BSD system may be unable to provide adequate warning on target vehicles approaching from behind at a high speed.
- The driver must ensure the normal operation of the BSD system, keeping its rear corner mmWave radars in good condition. For example, dirt, snow, or other obstructions need to be cleared right away.
- The BSD system gives a warning if unrelated targets at the rear side or in the rear (such as work zone barriers, large roadside billboards, reflectors in tunnels, or other objects with a large radar cross section) are wrongly selected as target vehicles.
- Detection may be affected or delayed in some environments. If the radar cross section of the target vehicle is too small (a bicycle, electric moped or pedestrian, for example), the system may fail to identify targets, leading to false alarms. In addition, detection may also be affected or delayed by noise or electromagnetic interference.

System Limitations

- Under some circumstances, it is difficult for the system to assist the driver, and detection may be affected or delayed. Possible circumstances include, but are not limited to:
 - The vehicle coming from behind changes the lane suddenly.

- Vehicles coming from behind are detected too late at sharp turns, slopes, or other settings.
- The target vehicle is obscured.
- Vehicles come from behind at a relative speed above 80 km/h.
- The vehicle is on a curve which is too sharp, or is entering or exiting a curve.
- The vehicle is running under severe weather, such as rain or snow.
- Rear corner mmWave radar(s) come off, are loosely installed, or are blocked.
- The vehicle encounters certain metal guardrails or similar road conditions.
- Targets that may not be responded include, but are not limited to, pedestrians and animals.
- The environment contains electromagnetic interference or other influences.
- Vibration or collision influence on sensor calibration of BSD's rear corner mmWave radars can degrade system performance. If this is detected, contact a BYD authorized dealer or service provider.

WARNING

- Blind spot assist only serves as a driver assistance function, so the driver must be fully responsible for driving safety.
- Influence of weather, road conditions, and other factors may cause blind spot assist to fail.
- Use blind spot assist based on your needs, traffic, and road conditions.

Head-up Display (HUD)*

Head-up display (HUD): The head-up display (HUD) function projects important information, including vehicle speed, speed limit, ACC, lane departure, BSD, etc., into the driver's field of view on the front windshield. It improves driving safety by preventing the driver from frequently changing the focus of eyes.

How to Use

- To enable or disable HUD, go to infotainment touchscreen →  → Vehicle Settings.
- By factory default, HUD is on and the image is displayed. When it is disabled, no HUD image is displayed. The system defaults to the previous settings when the vehicle starts.

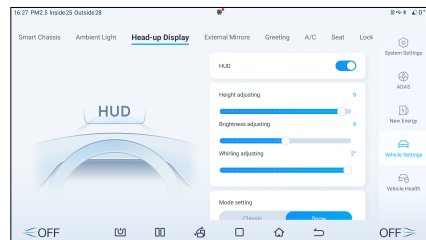

- Height adjusting: adjust the height of HUD virtual image in between -10 and 10. A total of 21 values are available, and the default value is 0.
- Brightness adjusting: adjust the brightness of HUD virtual image in between 1 and 11. A total of 11 values are available, and the default value is 6.
- Whirling adjusting: adjust the angle of HUD virtual image. A total of 11 values are available, and the default value is 0°.
- Mode setting: select Classic (default setting) or Snow mode according to the environment of the vehicle.



- Settings optional for display: Safe driving assistance can be selected and is enabled by default.

 **CAUTION**

- Do not put articles on the head-up display.
- Wipe the dust on the dust-proof board with soft cotton cloth or paper towel.
- No water or other liquid is allowed to flow into the opening of the head-up display.

Tire Pressure Monitoring

Direct Tire Pressure Monitoring System*

- The direct tire pressure monitoring system is an auxiliary system that monitors tire pressure in real time to improve vehicle safety and comfort and reduce tire wear and energy consumption due to insufficient tire pressure.
- You can access the instrument cluster menu by pressing  on the steering wheel, navigate to the driving information bar by pressing  and , and then select the tire pressure display page using the roller on the button.

Tire Pressure System Alarm

- When the pressure of any tire is lower than 80% of the standard tire pressure and the system is running, the tire pressure fault warning light lights up and the tire pressure value turns yellow. In that case, it is recommended to check for slow air leakage and inflate the tire to the correct pressure value.

- When the temperature of any tire is above 85°C for 3 consecutive minutes, the tire pressure system will give a high temperature alarm, and the temperature value of the corresponding tire will turn yellow. You are then recommended to stop the vehicle and wait for the tire temperature to decrease before further driving.
- When one or more tires leak air quickly and the system is running, the tire pressure fault warning light flashes constantly and the tire pressure value turns red. In that case, promptly stop the vehicle and replace tires or contact a BYD authorized dealer or service provider.
- When the system is running, if a fault occurs, the tire pressure fault warning light is solid on after flashing, and the message "Abnormal signal" or "Please check the tire pressure monitoring system" is displayed on the instrument cluster. In that case, check the tire pressure monitoring module, and for any surrounding electromagnetic source nearby. If the alarm persists for a long time, please contact a BYD authorized dealer or service provider.

 **CAUTION**

- The running time of the tire pressure monitoring module is related to the daily travel distance and other factors.
- The monitoring module regularly transmits tire pressure and other information to the display. Therefore, if the tire pressure drops suddenly or there is a flat tire, the monitoring module will not transmit data to the display until the next monitoring. In this case, the vehicle may be out

CAUTION

of control. If there is a flat tire and monitoring fails to inform, or if you feel that there are some tire problems, stop driving immediately instead of waiting for the display to signal an alarm.

- Incorrectly installed monitoring module affects the air tightness of the tire. It is recommended that the installation and replacement of the pressure monitoring module be carried out by professional technicians of a BYD authorized dealer or service provider in accordance with the requirements of the installation manual.
- Since tire pressure varies with regional temperatures, inflate or deflate the tires according to the values displayed on the instrument cluster and the standard tire pressure values.
- The tire pressure monitoring system may be disturbed by non-BYD approved electrical accessories on the vehicle. This is not a tire pressure system failure.
- The tire pressure system needs to be matched again after replacement of wheel rims or spare tires* or tire rotations. Please go to a BYD authorized dealer or service provider to re-match the tire pressure.

WARNING

- The system does not stop vehicle traveling in the event of abnormal tire pressure. Therefore, each time before driving, start the vehicle statically to check whether the tire pressure meets the requirements specified by the manufacturer.

WARNING

If not, do not drive, otherwise vehicle damage or personal injury can occur.

- If pressure is found to be abnormal while driving, check the tire pressure immediately. If the low pressure warning light comes on, avoid sharp turns or emergency braking, and reduce vehicle speed, pull it over to the curb and stop as soon as possible. Driving with low tire pressure can cause permanent damage to tires and increase the likelihood of tire scrapping. Serious tire damage can lead to traffic accidents, resulting in serious injuries or deaths.

Acoustic Vehicle Alerting System (AVAS)

The acoustic vehicle alerting system (AVAS) refers to the alarm to pedestrians near the vehicle when it is traveling at EV mode.

- When the vehicle runs at a low speed, it will make proper alerting sound to alarm the pedestrians.

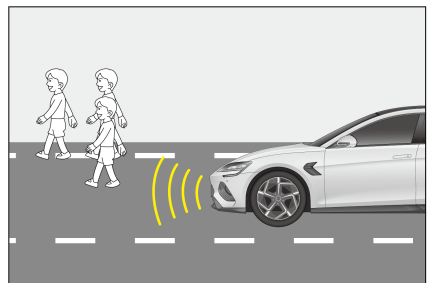

- When driving forward:

- The alert volume increases with vehicle speed in the range of 0 km/h to 20 km/h.
- The alert volume decreases with vehicle speed in the range of 20 km/h to 30 km/h.
- The alert stops automatically when vehicle velocity is over 30 km/h.
- The vehicle makes a continuous and balanced prompt sound when moving in reverse.

How to Use

To turn on or off the engine sound simulator, slide down the top status bar on the infotainment screen to display the shortcut page. AVAS has two vehicle prompt sound sources: Standard and Brand, in which Standard has three sound sources: Standard, Dynamic and Comfort, Brand has two sources: Standard and Comfort. To set the mode, go to infotainment touchscreen  → Vehicle settings → Notification.

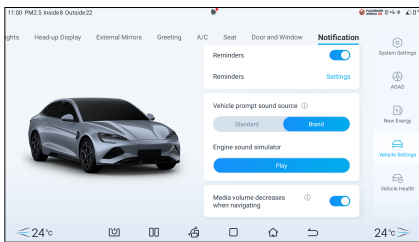

WARNING

- The AVAS pause switch can only be used if there are no other road users within a short distance, and no audio prompt is needed considering the surroundings (for example, in a traffic jam or on the highway). As long as pedestrians may appear around the vehicle, the AVAS needs to be turned on.

WARNING

- If the vehicle travels at a low speed with the AVAS disabled, it will not be able to remind pedestrians of the approaching vehicle, which may result in a car accident and, in severe cases, death or personal injury.
- If the AVAS prompt sound cannot be heard when driving at a low speed, stop the vehicle in a relatively safe and quiet place, open the window, then drive at a constant speed of 20 km/h in D gear and check whether an audio prompt can be heard from the front of the vehicle. If it is confirmed that there is no sound, contact a BYD authorized dealer or service provider to deal with it.

Panoramic View System

With the ignition switched on, tap **Vehicle View** on the infotainment system homepage or press the  button on the steering wheel to access the panoramic view.

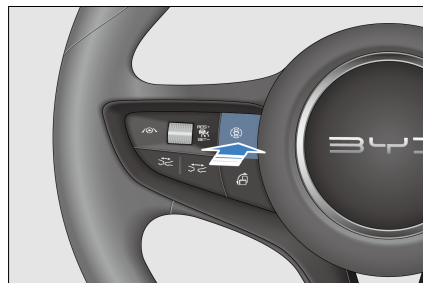

- Landscape mode:
 - Tap the front, rear, right, or left area of the vehicle icon on the right. View of the selected area is displayed in the image section on the left.

- In the single front and rear views, double-tap the image section to switch to a 180° perspective displayed in full screen.



- Tap the radar icon  in the panoramic view to enable the radar display, and tap it again to disable. When the radar display is enabled, a warning is displayed as the vehicle is approaching an obstacle.
- Portrait mode:
 - Tap any two of the front, rear, right, and left areas in the lower right section. Single views of the two selected areas are displayed in the upper and lower left image section.
- Tap the vehicle image in the lower right corner to switch between transparent and nontransparent vehicle images.
- After the vehicle starts, the image before last power-off is displayed on the transparent panoramic view screen. Foreign bodies shown may be inconsistent with the actual ones in the underbody and surrounding blind areas. The underbody image update will begin only after the vehicle has started to run and will be complete when the vehicle has been driven beyond its length.

 **WARNING**

- The panoramic view system provides transparent panoramic

 **WARNING**

view to show the image below the vehicle. This function is only for assisting in observation of area below the vehicle during parking/driving. Investigation of foreign objects below the vehicle and dangerous situations should be carried out in any other manner to ensure the safety of personnel and the vehicle.

- When the vehicle runs at a low speed, the transparent panoramic view function is affected by speed fluctuation or multiple stops, so there will be misalignment between the images below the vehicle and that outside the vehicle.
- The panoramic view system is only to be used for parking/driving assistance. It is not safe to rely solely on this system to park or drive the vehicle, because there are some blind spots in front of and behind the vehicle. The surroundings of the car should be observed in other ways during the parking/driving process, so as to avoid accidents.
- This system uses wide-angle fisheye cameras, so the object on the display screen may appear somewhat deformed in comparison with the actual object.
- When the side mirrors are not extended in place, do not use the panoramic view system; and when the panoramic view system is used for parking/driving, ensure that all the car doors are closed.
- The distance to an object displayed on the panoramic view screen may be different from the

WARNING

distance perceived subjectively, especially when the object is closer to the vehicle. Assess the distance in various ways.

- Cameras are installed above the front grille, side mirrors, and the rear license plate. Make sure the cameras are unobstructed.
- To prevent affecting camera performance, avoid spraying directly on the cameras when washing the vehicle body with high-pressure water. Wipe any water or dust off the camera in time.
- Protect the cameras from any impact to prevent damage or malfunction.
- After the vehicle is powered on, if you press the panoramic view start button or shift into reverse while the infotainment system is not fully activated, the output on the panoramic view screen will be delayed or the screen will flash. This is a normal part of the camera power-on process.

Parking Assist System

- During vehicle parking, the parking assist system detects obstacles by sensors, and prompts the driver with the proximity of obstacles by an image on the infotainment touchscreen and a speaker alarm.
- The parking assist system helps with reversing. Pay attention to the environment behind and around the vehicle during reversing.
- When you reverse the vehicle, a reversing image will be displayed

on the infotainment touchscreen automatically.

- After reversing ends, the interface will be restored.

REMINDER

- The safety lines for reversing are only for distance reference in no-load condition of the vehicle.
- For your driving safety, when the reversing image is displayed, all buttons will be disabled except some volume and phone related buttons.

WARNING

- The parking assist system ceases to operate when the vehicle is moving forward at over 10 km/h.
- Do not place any articles within the sensors' working range.
- To prevent sensor malfunction, do not wash the sensor area with water or steam.

Reversing Radar Power Switch

- To enable or disable the reversing radar system, go to Infotainment touchscreen  → ADAS → Parking Assist.
- When the ignition is on and EPB is released, the parking assist system is enabled automatically.

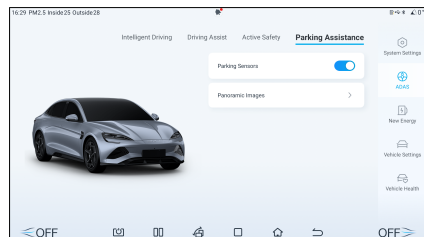

- When enabled, the system raises an alarm if obstacles are found surrounding the vehicle; when disabled, it does not.

Sensor Type

- When the sensor detects an obstacle, the corresponding image is displayed on the infotainment screen*, depending on the location of the obstacle and its distance from the vehicle.
- When the driver conducts parallel parking or reverse parking, the sensor measures the distance between the vehicle and the obstacle and communicates this information through the infotainment screen and the speaker. Be aware of the surroundings when using this system.

- ① Front right sensor
- ② Front left sensor
- ③ Rear right sensor

④ Rear left center sensor and rear right center sensor

⑤ Rear left Sensor

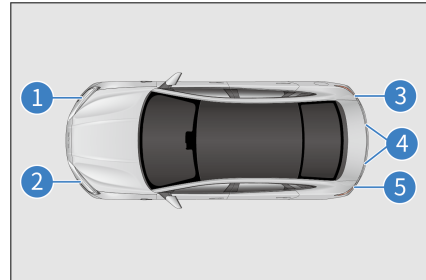



Distance Display Alarm

When the sensor detects an obstacle, the location of the obstacle and its general distance from the vehicle is displayed on the infotainment screen, and the speaker beeps.

Working example of center sensors

General Distance (mm)	Infotainment Display	Alarm Sound
About 700 to 1,200		Slow
About 300 to 700		Fast
About 0 to 300		Continuous

Working example of corner sensors

General Distance (mm)	Infotainment Display	Alarm Sound
About 300 to 600		Fast
About 0 to 300		Continuous

Working Sensors and Detection Range

- All sensors are activated upon reversing.
- The figure shows the sensors' detection range. Sensors have a range limitation, so the driver must check the surroundings before slowly reversing the vehicle.

- ① About 1,200 mm
- ② About 600 mm

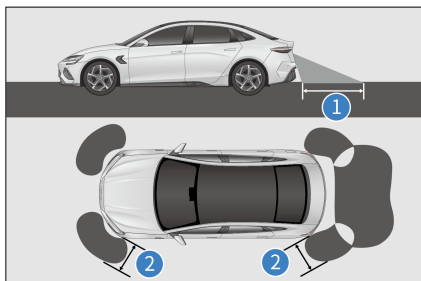

! REMINDER

- The parking assist system is only for assistance, and is not a substitute for personal judgment. Be sure to operate the vehicle based on your observations.
- Sensors will not work properly if accessories or other objects are placed within their detection range.

! REMINDER

- In some cases, the system cannot operate properly and will fail to detect certain objects as the vehicle approaches them. Therefore, be sure to observe the vehicle's surroundings at all times. Do not rely solely upon the system.
- Failure of the reversing radar system  is indicated by a message on the instrument cluster and a beep, contact a BYD authorized dealer or service provider for inspection as soon as possible in the event of the error message.

Sensor detection information

- Certain vehicle conditions and surroundings may affect the sensors' ability to accurately detect obstacles. Detection accuracy may be affected if:
 - There is dirt, water or fog on the sensor.
 - There is snow or frost on the sensor.
 - The sensor is masked in any way.
 - The vehicle leans significantly to one side or is overloaded.
 - The vehicle is moving on particularly bumpy roads, slopes, gravel or grass.

- The sensor has been repainted.
- The vicinity is noisy due to honking of vehicles, motorcycle engines, air brakes of large vehicles, or other noises that produce ultrasonic waves.
- There's another vehicle with parking assist system nearby.
- The vehicle is fitted with a tow eye.
- The bumper or the sensor was hit hard.
- The vehicle is approaching a high or zigzag curb.
- The vehicle is driving in the sun or in the cold.
- The vehicle is fitted with non-original, lower suspension.
- Except as described above, sensors may not be able to correctly determine the actual distance due to the shape of the object.
- The shape and material of obstacles may prevent sensors from detecting them, especially the following:
 - Electric wires, fences, and ropes.
 - Cotton, snow, and other materials that absorb radio waves.
 - Any object with sharp edges and corners.
 - Low obstacles.
 - High obstacles facing outwards towards the vehicle.
 - Any object under the bumper.
 - Any object close to the vehicle.
 - Persons near the vehicle (depending on the type of clothing)
- If an image is displayed on the infotainment touchscreen or there is a beep, it may be that the sensor detects

an obstacle or is interfered. If the issue persists, go to a BYD authorized dealer or service provider for inspection.



CAUTION

- To prevent sensor malfunction, do not rinse or apply steam to the sensor area.

Driving Safety Systems

For better driving safety, the following driving safety systems works automatically based on driving conditions. However, these systems only provide assistance, and excessive reliance on them is not recommended.

Intelligent Power Braking System

The intelligent power braking system is an advanced decoupled electro-hydraulic braking system, incorporating vacuum booster, electronic vacuum pump, and ABS/ESC functionality. The system assists vehicle braking according to the driver's demands. It offers advanced control functions such as anti-lock braking system (ABS), electronic brake force distribution (EBD), traction control system (TCS), vehicle dynamics control (VDC), comfort parking (CST), hill hold control (HHC), hydraulic brake assist (HBA) and controlled deceleration parking brake (CDP) to improve vehicle stability and comfort, and the recovery efficiency of brake energy.

Vehicle Dynamic Control (VDC)

When the vehicle turns suddenly while driving, the VDC system judges the driver's intention based on such information as steering wheel's angle and vehicle speed, and continuously compares with the actual condition. If the vehicle swerves from the driver's normal lane, the VDC will correct the situation

by engaging brakes to the corresponding wheels to help the driver control skidding and maintain directional stability.

Traction Control System (TCS)

TCS prevents the drive wheels from skidding during acceleration by reducing the motor power, and, when necessary, apply braking forces to prevent drive wheels from spinning. It makes the vehicle easy to start, accelerate, and climb under adverse driving conditions.

WARNING

- TCS may not work effectively in the following situations:
 - On slippery roads, even if TCS is working properly, it may not be able to control the direction and meet power requirements.
 - Do not drive in conditions where the vehicle may lose its stability and power.

Hill-Start Hold Control (HHC)

After the brake pedal is released, HHC maintains brake pressure for one second to prevent backward sliding.

Hydraulic Brake Assist (HBA)

When you press the brake pedal quickly, HBA detects that the vehicle is in emergency condition. It quickly increases the brake pressure to the maximum so that ABS can intervene more quickly and shorten the braking distance effectively.



Controller deceleration parking (CDP)* for parking brake



When you engage the EPB, the CDP function starts working so that the vehicle brakes at a constant deceleration (0.4 g if EPB is engaged but the brake pedal is not pressed, and 0.8 g if EPB is engaged and the brake pedal is pressed) until the

vehicle stops. The function stops working when the EPB is released.

ESC operation instructions

Intelligent power braking system has the following new functions compared with the original ESC system:

- Brake assist mode
 - It is used to adjust the brake pedal feel. The relation curve between the brake pedal depth and the vehicle deceleration varies across different modes for you to choose a preferred pedal feel.
 - You can select Comfort or Sport in infotainment touchscreen  → Vehicle Settings → Smart Chassis → Brake assist mode.
- Comfort Parking (CST)
 - Comfort parking: When the vehicle decelerates to stop in a non-emergency situation, intelligent power braking system reduces the stop-instant suspension pitch and impact by controlling the brake pressure of the four brakes, and provides a smooth stop feeling.
 - Go to the infotainment touchscreen  → Vehicle Settings → Smart Chassis to enable or disable comfort parking.
 - After the function is triggered, the braking distance may increase by 2-5 cm, so increase the distance from the vehicle or obstacle ahead accordingly before stopping your vehicle.
- Brake disc wiping
 - Brake disc wiping function: When the wiper switch is on or the rain sensor detects rain, the integrated brake control system applies a small brake pressure to all four brakes so that pads come into contact with discs to remove the water film from the

- discs. This shortens brake response time and braking distance.
- As long as the system detects rain or the wiper ON signal, the brake discs are repeatedly wiped at certain intervals to improve safety.
 - ESC working
 - If there is a risk of skidding or backsliding when the vehicle starts on a slope, or if either drive wheel is spinning, the ESC indicator flashes to indicate that ESC system is working.
 - Disabling ESC
 - If the vehicle gets stuck in snow or mud, ESC may reduce power output from the motor to the wheels. In this case, you may need to turn off the system to get out of the jam.
 - Turning off ESC
 - To turn off the ESC system, tap Infotainment system  → ADAS → Active Safety → ESC. ESC also checks its operating status in real time. If ESC OFF switch is pressed while ESC system is working, the system will complete the active intervention control rather than executes the "shutdown" command immediately. ESC is disabled only after the intervention control is complete.
 - Some functions of the ESC system may be re-enabled if you press the ESC OFF switch again or the vehicle speed exceeds the threshold (80 km/h). In order to prevent ESC from being turned off suddenly, ESC can be activated again only when it is not in a vehicle dynamic intervention state.
 - Restarting ESC after the motor is powered off
 - When the ESC system has been turned off, restarting the motor will automatically restart ESC system.
 - ESC system start and speed linkage
 - If the ESC system is turned off, when the vehicle becomes extremely unstable as the speed increases and exceeds the threshold (80 km/h), the ESC system starts on its own.
 - ESC activated
 - If the ESC fault indicator  flashes, drive with caution.
 - Turning off ESC
 - Be careful when ESC is disabled, and drive at speeds suitable for road conditions. The ESC system ensures vehicle stability and its driving force. Never turn it off unless necessary.
 - Tire replacement
 - Make sure all tires are of the same size, brand, tread, and total load. In addition, be sure to inflate tires to the recommended pressure.
 - Neither ABS nor ESC will work properly if the vehicle is fitted with different tires.
 - For details on tire or wheel replacement, it is recommended to contact a BYD authorized dealer or service provider.
 - Tire and suspension handling
 - The use of any defective tire or modified suspension affects the driving safety system and may cause the system to fail.

Anti-lock Braking System

- The ABS hydraulic system has two separate circuits, each running diagonally through the vehicle (left front wheel brake connected to the right rear wheel brake). If one circuit fails, two wheels can still be braked.

- ABS helps maintain the steering control by preventing the wheels from locking or skidding when brake is engaged suddenly or on slippery roads.

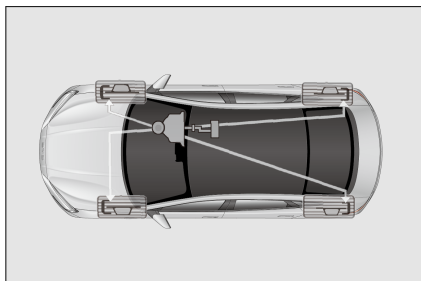

- When the front tires skid, there is no steering control, which means that the vehicle still moves forward even though the steering wheel is turned. ABS helps prevent locking and maintain steering control since pulsating prompt brake is much faster than human reaction.
- Never pulsate the brake pedal; otherwise, anti-lock braking system (ABS) may malfunction. While steering away from danger, a firm and steady pressure should always be maintained on the brake pedal for the ABS to work.
- When the ABS is working, the brake pedal will vibrate, which may produce noise. This is normal because the ABS is pulsating the brake quickly.

Electronic brake force distribution (EBD)

- The EBD is an auxiliary function of ABS. Before ABS acts, if the skid rate of rear wheel is high, ABS adjusts the brake pressure of rear wheel for a smoother and more ideal brake force distribution.

WARNING

- ABS cannot work effectively under the following conditions:
 - Tires with inadequate grip are used (e.g., excessively worn tires used on snow-covered roads).
 - The vehicle skids when driving at a high speed on slippery roads.
- ABS is not designed to reduce the braking distance of the vehicle. Always keep a safe distance from the vehicle ahead when:
 - Driving on slippery, muddy, sandy or snowy roads.
 - Driving on roads with multiple potholes or on uneven roads.
 - Driving on bumpy roads.

CAUTION

- If the ABS fault warning light is still on while the braking system warning light is on, immediately park the vehicle in a safe place. It is recommended to contact a BYD authorized dealer or service provider.
- In this case, if brakes are applied, the ABS will not work and the vehicle will become extremely unstable.
- ABS does not reduce the time and distance required to stop the vehicle. This device only helps you control steering when braking. Please always keep a safe distance from other vehicles.
- ABS cannot prevent skidding caused by sudden direction change, such as trying to make a sharp turn or change lanes

**CAUTION**

suddenly. Always drive carefully at a safe speed, regardless of road and weather conditions.

- ABS does not prevent decrease in stability either. When applying the brake in an emergency, the steering should be moderate. A large or sharp turn during the driving can cause the vehicle to swerve into oncoming traffic or run off the road.
- When driving on wet or soft or uneven roads (such as waterlogged concrete roads, waterlogged epoxy painted roads, sandy roads, snowy roads), vehicles equipped with ABS may require longer braking distances than vehicles without ABS. In such cases, reduce the vehicle speed and keep a greater distance from other vehicles.

Intelligence Torque Adaption Control (iTAC) System*

When the vehicle is running, the intelligence Torque Adaption Control (iTAC) system can determine the driver's driving needs and vehicle state according to the information such as steering wheel angle and motor speed, quickly identify the vehicle state through the unique control architecture and algorithm, and dynamically adjust the driving torque of the front and rear axles, so that the driving state of the vehicle can better meet the driver's needs and the vehicle can still obtain better driving performance under complex road conditions. When the wheels show signs of slipping, this system can adjust the driving torque of the front and rear

axles rapidly to ensure the stability of the vehicle torque and make the vehicle obtain better driving performance under different road surfaces.

- Tap infotainment system →  → New energy → iTAC to start.

**WARNING**

- This function is not designed for unbridled driving. Make sure the braking system works normally in the following situations:
 - Unbridled driving behaviors such as drifting, and driving on continuous bends
 - Muddy, sandy, or snowy roads
 - Roads with potholes or uneven roads
 - Bumpy roads

**REMINDER**

- When there is braking participation or braking action, such as the driver stepping on the brake pedal and ESC triggering, this function will exit the priority guarantee braking.

Driver Attention Warning (DAW)

Driver attention warning (DAW) system evaluates the driver's degree of fatigue by the vehicle operation status. The driver would be reminded according to the evaluation results to ensure driving safety.

How to Use

With the vehicle powered on, set the warning in infotainment touchscreen →

🚗 → ADAS → Driving Assist → Driver Attention Warning (DAW). For safety considerations, the setting is valid on the current trip only and will revert to the default mode on the next trip.

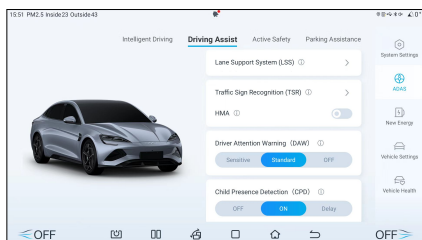

! WARNING

- The driver should pull over as soon as possible when feeling tired.

! CAUTION

The driver monitoring system is only an auxiliary system and is not capable of effective recognition and alarm-raising in all situations. It cannot completely replace the driver's subjective observation and judgment. The driver must maintain control of the vehicle at all times, complying with all road laws and regulations, and taking full responsibility for the vehicle.

Child Presence Detection (CPD)

After the vehicle is powered off, child presence detection is performed if any door is opened and then all doors are closed or locked. If child presence is detected, an alarm is given in the form of light flashing and honking. The A/C will be switched on soon after. To cancel the alarm, unlock or open any door.

How to Use

Access this function in infotainment touchscreen → 🚗 → ADAS → Driving Assist → Child Presence Detection (CPD).

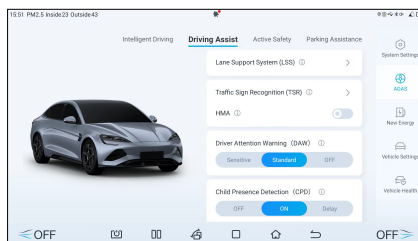

- There are three functions on the setting: **OFF**, **ON** and **Delay**.
- By default, the system is switched on each time when the vehicle is powered on.
- Tap **OFF** to deactivate the alarm in this trip.
- Tap **Delay** to extend the alarm (for five minutes) in this trip.

System Response

- If life presence is detected, the initial alarm (light flashing and honking) starts within 10 seconds and will last for about six seconds.
- If the alarm is not cancelled, the alarm will be upgraded in 90s (light flashing & honking) and will last for 25 minutes.
- The A/C will be switched on three minutes after alarm escalation if it is not canceled, and will keep running for about 30 minutes.

! WARNING

- The system can reduce the harm resulting from high temperatures by prompts and turning on the A/C, but cannot completely avoid the harm.

WARNING

- After the system issues a prompt, please promptly check whether there is any child/pet in the vehicle to avoid further harm.

CAUTION

- Misidentification or false alarm could happen.
- The alarm may be given for adults, children, pets, or other lives detected.
- The alarm cannot be canceled by unlocking the vehicle from the app.
- The system may not be able to trigger an alarm or switch on the A/C if the SOC is low. Keeping the vehicle at high SOC is recommended.

Other Main Functions

Interior Rearview Mirror

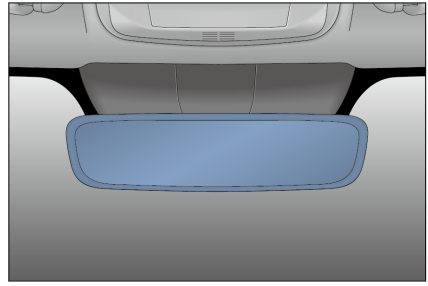

The automatic anti-glare interior rearview mirror is equipped with electronic anti-glare function, which automatically adjusts the lens color of the mirror according to the surroundings to reduce the interference of rear glare on the driver's field of vision.

**WARNING**

- Do not adjust the interior rearview mirror while driving, as this may prevent the driver from controlling the vehicle, resulting in personal injury or death due to accidents.
- Do not hang heavy objects from the interior rearview mirror, or shake or drag it with force.

Power Side Mirrors

Using the switch for electric side mirrors, the driver can adjust the mirrors to see the sides of the vehicle in the mirrors.

- Selection switches: used to select the side mirror to be adjusted.
 -  : Left side mirror button
 -  : Right side mirror button



- Side mirror adjustment buttons  : used to adjust the side mirror lens. Press the switch indicating the desired direction.

REMINDER

- The electric side mirror has the turning function upon reversal. When the vehicle is being reversed, the electric side mirror automatically turns down.

Folding Side Mirrors

Folding side mirrors manually

Push the outer edge of a side mirror to rotate it around the folding axis to the locked position.

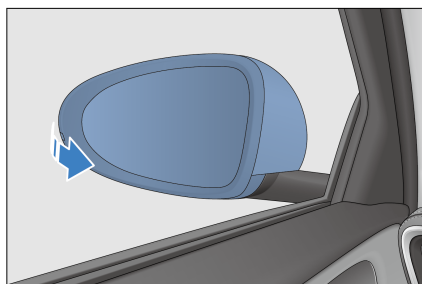

Electric exterior rearview mirror fold switch

Enable or disable the side mirror auto-fold function in infotainment touchscreen

→  → **External Mirrors.**

- Press the  button to fold the side mirrors with power. Press the button again to unfold the mirrors.
- When entering anti-theft status, the two rearview mirrors automatically fold, and when removing anti-theft status, the two rearview mirrors automatically expand.

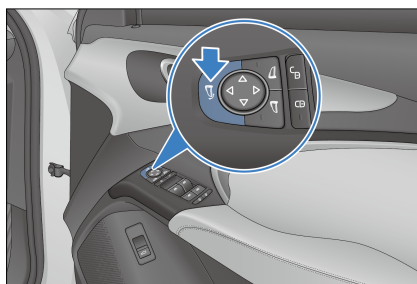

Wipers

Inspect wiper blades for cracks or partial hardening at least every six months. If these findings are noted, wiper blades should be replaced. Otherwise, the windshield will streak or will be left unclean after wiping.

CAUTION

- Do not open the hood when wiper arms are lifted, as this may damage the hood and wiper arms.

Replacing Wiper Blades

With the vehicle powered up (OK), users can turn on the wiper maintenance function by tapping Infotainment  - Vehicle Health - Maintenance Settings. After this function is turned on, the wiper will run to a high position and then stop to facilitate maintenance and replacement of the wiper. After maintenance, the driver can turn off the wiper maintenance function to make the wiper return to the reset position.

1. Pull up the wiper arm at the driver side, and then pull up the other at the passenger side.
2. Press the wiper lock button.

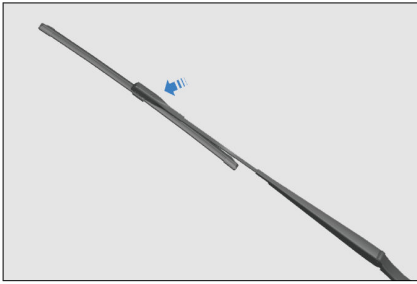

3. Hold the wiper blade and pull it out along the indicated direction.
4. When installing a new wiper blade, follow the reverse procedure.

**CAUTION**

- Do not open the hood when wiper arms are lifted, as this may damage the hood and wiper arms.
- Do not directly push the wiper arm to let the wiper blade straightly strike onto the windshield when laying down the wiper blade after washing the vehicle.
- Do not bend wiper blades, or block them when the wipers are operating.

05

IN-VEHICLE DEVICES

Infotainment System.....	146
A/C.....	147
Storage.....	154
Other Devices.....	156

Infotainment System

Infotainment Touchscreen

When the vehicle is powered on, the initial screen is displayed for

several seconds and the infotainment system starts to work. To better experience infotainment functions, such as intelligent voice control, apps and video calls, the system must be used after network connection.

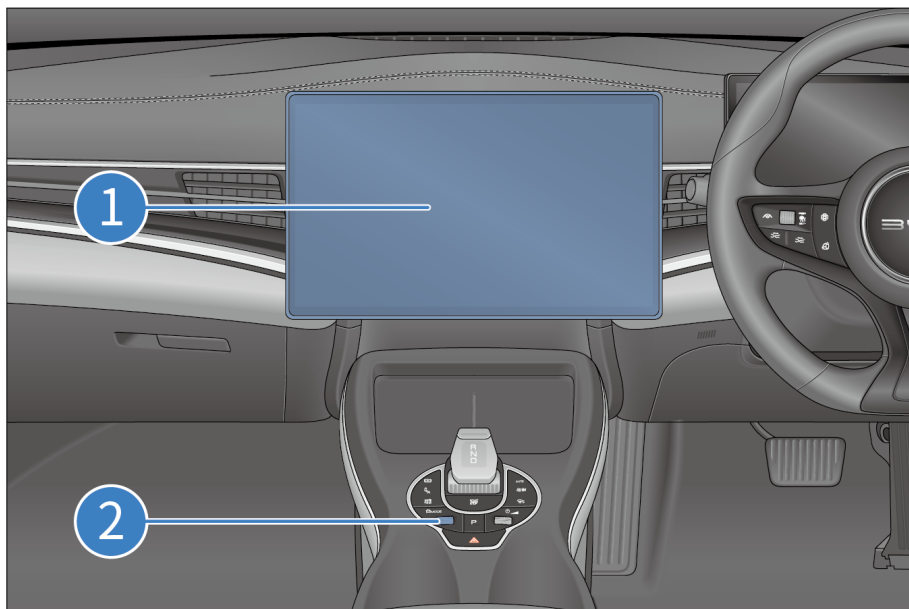

① Infotainment touchscreen (PAD)

② Scroll button

- With the infotainment system activated, press this button to turn off the PAD, and press it again to turn on the PAD; press and hold it for 3s to restart the infotainment system.
- With the infotainment system or radio activated, roll up/down the roller (toward the front/rear of the vehicle) to turn up/down the volume. The volume ranges from 0 to 39. A mute icon is displayed when volume is 0.

WARNING

- Do not use a high-power inverter in the vehicle, as this may cause infotainment system malfunction.
- Do not format or root the device without authorization, as this may cause infotainment system or vehicle malfunction.
- In driving, please use the infotainment system in landscape mode wherever possible for your safety.

CAUTION

- To prevent damage to the touchscreen:
 - Touch the screen gently. If there is no response, remove finger from the screen then touch it again.
 - Clean the screen with a soft damp cloth. Do not use any cleaning product.
- Using the touchscreen
 - When the screen temperature is low, the image displayed may be darker or the system may work slightly slower than normal.
 - The screen may be dark or difficult to see when you are wearing sunglasses. In that case, change the viewing angle or take off the sunglasses.
 - Buttons in gray on the touchscreen are in inactive states.
- The touchscreen interface shown here is for reference only.

A/C

A/C Panel

- ① Auto button
- ② A/C power button
- ③ Defrost button for front windshield

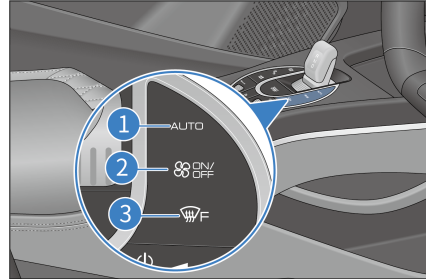

A/C Operation Interface

A/C settings interface



- | | | | |
|---|-------------------------|----|---------------------------------------|
| 1 | A/C settings | 10 | Front windshield defroster |
| 2 | Air Purification | 11 | Rear defroster |
| 3 | Vent/Heat | 12 | Circulation mode |
| 4 | A/C operation interface | 13 | ION button |
| 5 | A/C ON/OFF | 14 | Front passenger's temperature control |
| 6 | Auto mode | 15 | Fan speed control |
| 7 | A/C button | 16 | Air distribution |
| 8 | Max cooling | 17 | Driver's temperature control |
| 9 | Ventilator | 18 | DUAL |

! REMINDER

- A/C odor:
 - It is normal that there may be a damp and moldy smell just after the A/C is turned on. During the operation of the automobile A/C, A/C condensation often remain in the evaporator, and the wet evaporator can easily absorb unfiltered body sweat,

! REMINDER

- smokes, etc., inside the vehicle. Condensation not blown dry makes the dark and damp evaporator surface prone to mold, which is very likely to produce unpleasant odors by long-term fermentation.
- How to prevent A/C odors:



REMINDER

- Turn off the A/C and ventilate with natural air before parking to keep the air inside the vehicle relatively dry.
- Inspect, clean, or replace the filter regularly.
- Try to keep the cabin clean and fresh.
- If the odor persists after odor prevention methods are used, it is recommended to contact a BYD authorized dealer or service provider for repair.

Function Definitions

Auto mode

- Tap the auto button, its indicator lights up on the front A/C panel, the auto mode is activated.
- If any manual control button is pressed in automatic operation mode, the corresponding status of the button pressed will be set and other statuses will continue to be adjusted automatically.

A/C ON/OFF

- Press this button or tap "ON" on the A/C operating interface to turn off the A/C. The air outlet mode keeps unchanged, while the air input mode turns to recirculation mode. Press this button or tap "ON" again to turn on the A/C.
- With the A/C turned off, press this button or tap "ON" to turn on the A/C in the memorized modes, with the set temperature, blower speed and air outlet mode being those when the A/C was turned off the last time.

Fan speed control

Tap the suitable blower speed level button to set the blower speed at a desired level. A higher blower speed level indicates a higher air volume.

Front windshield defroster

- Press this button on A/C control panel or tap "Front" on the touchscreen to distribute air to the front windshield and side windows. Press this button again or tap "Front" on the touchscreen; the A/C will return to the status used last time.
- Press this button on A/C control panel or tap "Front" on the touchscreen to activate the defrosting and demisting function and no matter whether the compressor control button is operated or not, the A/C will also be turned on.

Temperature controls

- Driver's temperature control
 - In the individual mode: temperature regulation on the driver's side.
 - In the relative mode: temperature regulation on the driver and front passenger sides.
 - To increase/decrease the temperature, tap the upper/lower arrow on the screen, or touch the temperature display area and then swipe downwards/upwards.
- Front passenger A/C temperature adjustment
 - In the individual mode: For the front passenger seat temperature regulation.
 - In the relative mode: When the front passenger's temperature control is operated in relative mode, the A/C system will automatically switch to individual mode.
 - To increase/decrease the temperature, tap the upper/lower arrow on the screen, or touch the

temperature display area and then swipe downwards/upwards.

- "Lo"/"Hi" is displayed when the temperature is set to the lowest/highest value.

DUAL

- Tap this button to switch from individual mode to relative mode.
- Individual mode: The temperature of the driver's side and front passenger's side can be set separately. The button icon will be lighted after the individual mode is selected.
- Relative mode: Adjust the driver side and front passenger side set temperature at the same time by the driver side temperature control. The button icon is grey in the relative mode.
- When the front passenger's temperature control is operated in relative mode, the A/C system will automatically switch to individual mode.

Max cooling

Tap this button to switch the A/C to the maximum cooling control mode. The temperature is set to "Lo", the fan speed is set to the maximum, the recirculation mode is activated, and air is directed to face level. Tap this button again to deactivate A/C ventilation control and enter AUTO mode.

A/C button (cooling/heating)

Tap this button to turn on the A/C (cooling/heating), the icon lights up and cooling or heating begins. Tap this button again to turn off the A/C. The icon goes out.

Circulation mode

Tap this button to switch to recirculation mode. Tap it again to switch to fresh air mode.

Rear defroster

- With the vehicle power in "OK" mode, tap this button to activate the rear windshield defroster/demister and side mirror defroster/demister*.
- The thin electric heating elements inside the rear windshield and side mirrors will make the windshield and mirrors clear. After the windshield and mirror surfaces are clear, tap this button again to turn off the defroster/demister. The system will automatically shut down after the defroster/demister works for 15min.



WARNING

- Do not touch the side mirrors when the demister is activated, because their surfaces will be hot.
- When cleaning the inside of the rear windshield, take care not to scratch or damage electric heating wires or junctions.
- Be sure to turn off the demister switch when the vehicle power is in a mode other than "OK" to prevent the 12V battery discharging.

Ventilation

- Tap this button to activate A/C ventilation control. The outlet air is natural air, and the blowing rate is 1 by default without cooling or heating. Tap this button again to exit.

Blowing mode

- A/C blowing mode
- Tap the corresponding icon on the infotainment system to select the corresponding blowing mode.

- You can turn on multiple air distribution modes at a time (up to three).
- Adjustments can be made according to the following air supply.

Blowing face: Air flows to the face level.

Blowing legs: Air flows to the leg level.

Defrost: Air flows to the front windshield and side windows.

Intelligent A/C ON Method

Remote A/C ON with intelligent key

- You can turn on the A/C through the remote control key to gain a comfortable interior environment in advance.

Turning on A/C by voice

- Control the A/C settings by the voice button on the steering wheel or by saying "Hi BYD".

Turning on A/C by cloud service

- You can turn on the A/C through BYD app interface to gain a comfortable interior environment in advance.

Usage Precautions

- To quickly cool down the interior after long exposure to sunlight, drive for a few minutes with the windows open to exhaust hot air and speed up A/C cooling.
- Make sure that the air intake grille in front of the windshield is not blocked (for example, leaves or snow).
- Avoid blowing cool air onto the windshield in humid weather. The inner and outer temperature difference can cause glass fogging.
- Keep the space under the front seats clear to improve air circulation.

- In cold weather, run the fan at high speed for one minute to remove snow or moisture from the intake passage and reduce fogging.
- In dusty or windy driving conditions, close all windows, If the dust raised by other vehicles still enters the vehicle even if all windows are closed, it is recommended to set the air intake mode as recirculation mode and set the blower speed at any position other than "0".
- To speed up cooling, adjust the temperature to "Lo" and use the recirculation mode for a few minutes.
- Use recirculation mode for a few minutes for quick heating in cold weather, and switch to fresh air mode to prevent fogging after cabin is heated up.
- In heating mode, press the compressor control button to light up the button (turning on the compressor), which can reduce airflow moisture.
- In the ventilation mode, the system introduces the natural wind from outside, which is suitable for spring and autumn.

Vents

To access the A/C setting page, go to Infotainment touchscreen .

The vent area is the adjustment area of A/C vents. Touch the sliding area to adjust the air outlet direction.



- Driver side front blowing button
 - Press this button to distribute air to the driver. The air begins to sweep around the driver's head.
- Driver side surrounding button
 - Driver side vent starts blowing surrounding people to avoid human body.
- Driver side air sweep button
 - Driver side vent starts blowing mode and wind direction begins to sweep horizontally.
- Driver side free wind button
 - The left vent and right vents on the driver seat are adjusted manually, you can adjust the wind direction casually.
- Driver seat side air vent close button
 - The left vent and right vents on the driver seat will close.
- Smart vent button
 - The A/C will automatically switch various air outlet modes such as front blowing, blowing surrounding and air sweeping according to the state.
- Front passenger side front blowing button
 - Press this button to distribute air to the front passenger. The air begins to sweep around the front passenger's head.
- Front passenger side surrounding button
 - Front passenger side vent starts blowing surrounding people to avoid human body.
- Front passenger side air sweep button
 - Press this button to start sweeping air on the front passenger side. The air begins to sweep in the range of left and right vents.
- Front passenger side free wind button
 - The left and right vents on the front passenger seat are adjusted manually. Users can adjust the air direction of these two vents at will.
- Front passenger seat side air vent close button
 - The left and right vents on the front passenger seat will be closed.

Rear vent

- Toggle the vent stick to adjust the outlet angle of air flow.
- Turn the roller to adjust the size of the vent or to open/close the vent.

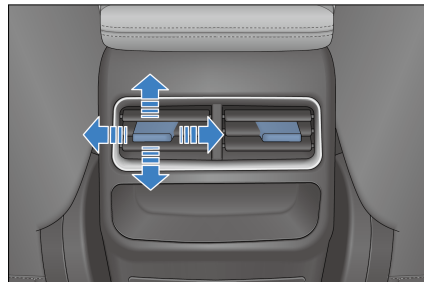

Air Purification System

The air purification system purifies airborne PM2.5 particles. When A/C is turned on, the system thoroughly removes PM2.5 particles from the air blown into the cabin.

Air purification operation interface

Tap "Air purification" on the infotainment page. The PM2.5 operation interface is displayed.



- | | | | |
|---|------------------|---|--------------------|
| 1 | Air purification | 3 | Quick purification |
| 2 | PM2.5 detection | 4 | ION |

PM2.5 detection

Tapping this button lights it up and activates detection of real-time PM2.5 concentration inside/outside, which will be displayed on the infotainment touchscreen. The detection stops when the button turns off.

Quick purification

Tap this button to activate quick purification. Tap it again to deactivate quick purification.

ION

- Function: sterilization, air purification, refreshing.
- Tap the "ION" button on the A/C or green air purification interface to inactivate or activate the ION.

! REMINDER

- The PM2.5 value detected by the on-board air purification (PM2.5) detector is the PM2.5 value in the air near the vehicle carrying the device in a short time, which should be different from the daily or real-time PM2.5 value declared by national and relevant government authorities.
- The frequency of PM2.5 detection should be reduced in the following environments:
 - Sandstorms and other such extremely harsh environments.
 - Cold regions (with ambient temperature below -20°C).
 - High humidity environments (relative humidity >90%).

! REMINDER

- Environments with a change in temperature (prone to condensation), such as driving in from a cold environment to a high-temperature indoor environment or parking lot.
- Running maximum air flow speed in recirculation mode can quickly reduce the concentration of fine particles in the air inside the vehicle.
- In order to reduce odors from the A/C, if the A/C is already turned on, the A/C blower may keep running for a while after the vehicle is powered off and locked. That is because the condensed water on the surface of the evaporator needs to be dried to prevent mold fermentation. It is normal for the A/C blower to start running automatically when you lock the vehicle. No need to worry about it.

A/C Settings

① A/C settings interface

- Tap this button to display A/C settings screen.
- Tap this button again to hide the A/C setting interface.

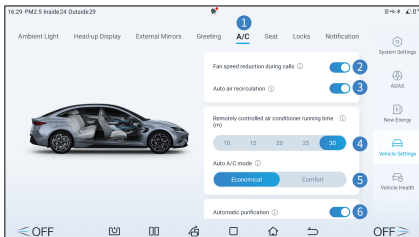

② Fan speed reduction during calls

- Tap this button to enable this setting.

③ Auto air recirculation

- Tap this button to enable this setting.

④ Remotely controlled air conditioner running time(m)

- Tap this button to set the time for remote A/C running.

⑤ Auto A/C mode

- Two options are available: Economical and Comfort.

⑥ Automatic purification

- Automatic purification on/close setting.

Storage

Glove Box

- Pull to open the glove box.
- Push the lid up to close it.

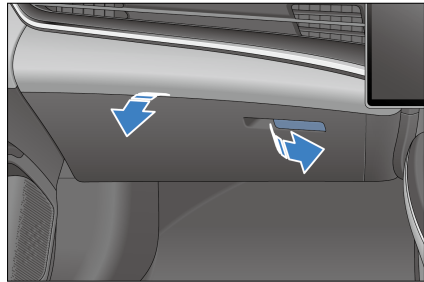

! REMINDER

- To reduce the possibility of personal injury in the event of an accident or emergency braking, keep the glove box closed while driving.

Cubby Box

To use the cubby box, press the switch on the front of cubby box to open it.

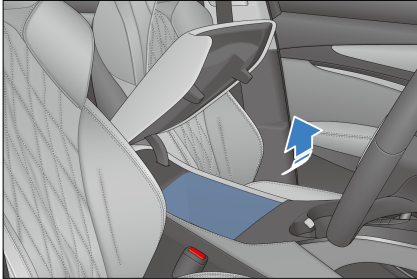

! REMINDER

- Keep the front cubby box closed while the vehicle is in motion.

Cup Holder

Front Seat Cup Holder

The cup holder is used to securely hold cups, movable ashtray, beverage can, etc.

Driver's side lifting cup holder*

- Lowering - press the cup or directly press the bottom of the cup holder to lower the cup holder by 40 mm.
- Rising - press ① unlock button to rise the cup holder to the initial position.

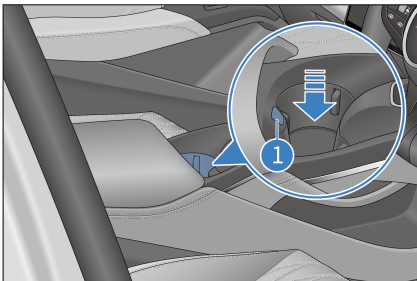

! REMINDER

- The cup holder should hold a cup or beverage can securely to avoid any liquid spilling from the cup or can, damaging the front USB ports.
- If such sundries as melon-seed shells and fine iron wires are thrown into the sliding groove of the cup holder, the cup holder will be stuck and unable to rise.

Rear Seat Cup Holder

Flip the rear seat armrest to use the cup holder.

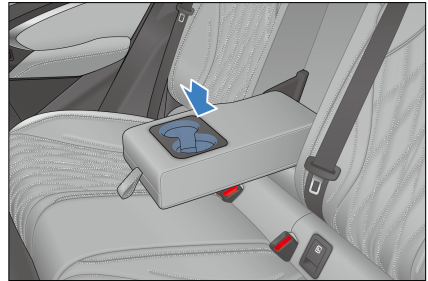

! CAUTION

- When using the cup holder, do not start or brake the vehicle suddenly to prevent liquid spillage and burn you or other passengers.
- Do not place an open cup or untightened beverage bottle in the cup holder, so as to avoid liquid spillage when you are opening and closing the doors and driving.
- To ensure safe driving, the driver is strictly prohibited from taking the cup out or placing it in the cup holder while driving.

Storage Box on Interior Panel

Storage boxes are available on all doors to hold cups and canned beverages.

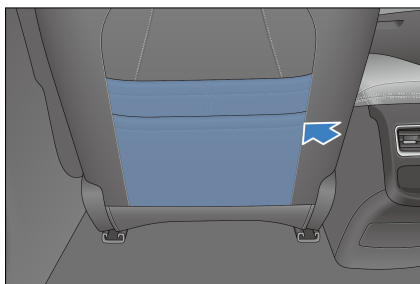
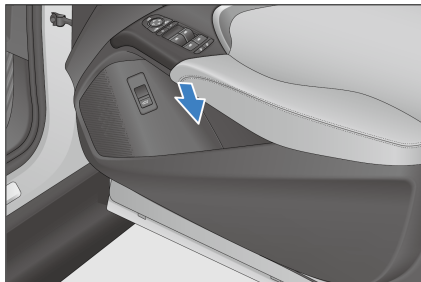

Engine Compartment Storage

Open the hood to show the front storage box, which can be used to store articles.

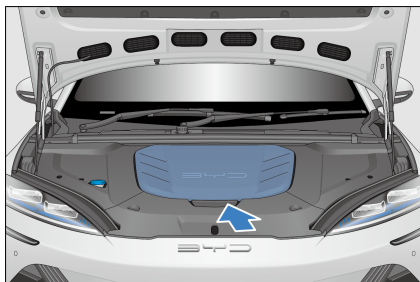

Bill Box

Tap the lid to open the bill box.

Pull up the Bill box to close it.

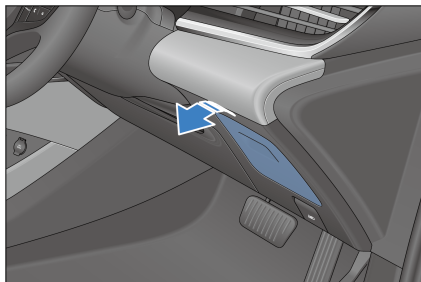

Seatback Pockets

There are file pockets at the back of the front seats.

Other Devices

Sun Visors

① Sunvisor

- To block sunlight from the front, pull the sunvisor down.
- To block sunlight from a side, remove the swivel sleeve from the fixed support and turn the visor towards the side window.

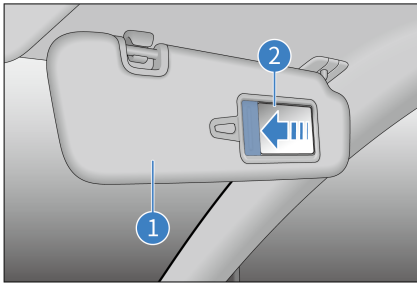

②Vanity mirror

- When a vanity mirror is installed, flip down the sun visor and slide the mirror cover for use.

! REMINDER

- Correct use of the sun visor improves driving safety and comfort.

Grab Handles

- Pull the grab handle down for use. The handle returns to its original position when released.

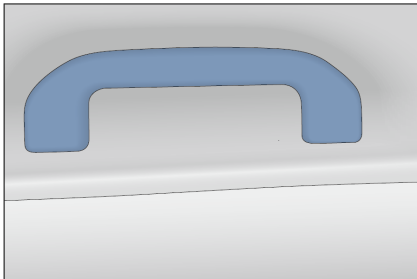

! CAUTION

- Do not hang any heavy objects from the grab handles.

12V Auxiliary Power

- It is used for accessories with 12V DC working voltage and no more than 10A working current.
- The 12V auxiliary power is available only when the ignition switch is on "OK". Lift the cover to use it.

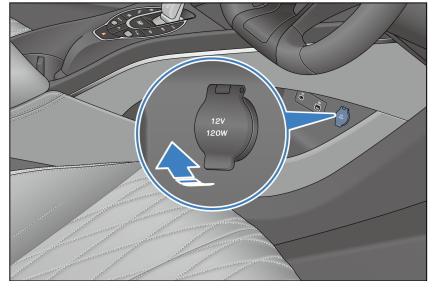

! CAUTION

- To prevent fuses from blowing, the power consumption must not exceed 12V/120W of total vehicle load.
- To prevent the starter iron battery from exhausting its power, do not use the 12 V auxiliary power supply for a long time when the driving motor is not running.
- When the 12 V auxiliary power is not in use, close its cover. Do not insert any object other than a suitable plug into the 12V auxiliary power socket or let any liquid ingress the socket, as electrical failure may result.

USB Ports

Front-row USB ports

They are located at the hollowed-out part below the auxiliary dashboard near the driver's side seat.

- ① Type-C fast charge port
- ② USB data transmission port

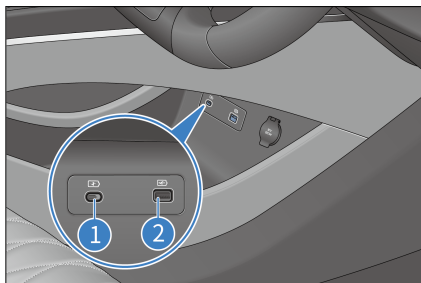

Rear-row USB ports

- The rear USB ports are located behind the center console cubby, and can be opened by pressing the protective cover.

- ① USB charge port
- ② 60W fast charge port

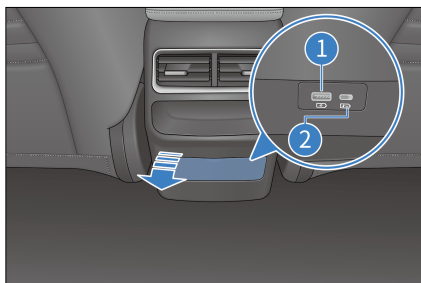

- The power outlet can be used only when the ignition is on.

Wireless Phone Charger

- The wireless phone charger is located at the front of the cubby box. When the ignition switch is on OK, put the phone on the non-slip rubber pad in the wireless charging area with the phone screen facing up. The phone automatically begins wireless charging, and a charging

icon is displayed on the infotainment touchscreen.

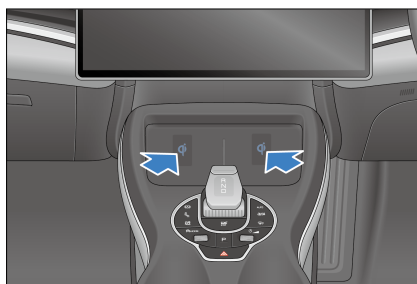

- The wireless charger only works with Qi-certified phones.
- Wireless phone charging uses a coil to transmit electrical energy to a phone battery through electromagnetic wave induction so that the phone can be charged without a cable connection.

! REMINDER

- This function allows charging two phones at the same time.
- A phone case that is too thick may prevent charging.
- You can use the Qi soft switching via PAD to separately activate/deactivate the wireless charging on the left or right side.
- On bumpy roads, wireless phone charging may intermittently stop and then resume.
- Try to ensure that the surface on which a mobile phone is placed is parallel to the charging module. If the phone moves from the wireless charger area and stops charging, move it back.
- If the phone cannot be charged properly, ensure that there are no foreign objects in the wireless charger area, or wait for the



REMINDER

wireless charger area to cool down before trying again. If it is still impossible to charge the phone, contact a BYD authorized dealer or service provider.

- After power-off, if the phone is still charging and the driver's door is opened, the instrument cluster sounds an alarm and the message "Please take your cell phone with you" is displayed for five seconds.



CAUTION

- Ensure your smart key is more than 25 cm away from the wireless charger area when the wireless charger system is working.
- To avoid wireless charger dysfunction or even accidents, do not place coins, metal keys, metal rings, or other articles containing metal in the wireless charger area together with the phone.
- To avoid damage to the charger area, do not place heavy objects on it.
- If the phone wireless charger system is faulty and does not work properly, it is recommended to contact a BYD authorized dealer or service provider.
- BYD will not assume any responsibility for any problems caused by improper use. If the product is disassembled or modified, the free warranty will be terminated.
- For safety reasons, do not leave an unattended phone being charged in the vehicle.



CAUTION

- For safety reasons, refrain from checking phone charging status while driving.
- If a metal item is found between the device and the charger rubber pad during charging, do not remove the metal item with bare hands to prevent burning.
- For better charging, the center of the phone coil must be aligned with the center of wireless charger (indicated with text in the charging area).
- Prevent any fluid from coming into contact with the charger area. The wireless charger will malfunction if water enters the wireless charger via the gap around the rubber mat.
- Charging may stop at high temperatures, and will resume once the temperature drops.
- The wireless phone charger system can charge Qi-certified phones, and non-Qi-certified phones are not guaranteed for normal charging.
- BYD makes no commitments for problems caused by external wireless charging coils. Please use with caution.
- To avoid burning cards with chips, such as bank cards, do not place them between the phone case and the phone during charging.

06

MAINTENANCE

Maintenance Information.....	162
Regular Maintenance.....	167
Self-Maintenance.....	171

Maintenance Information

Maintenance Cycle and Items

Maintenance Plan

- The maintenance plan is designed to ensure stable driving, failure reduction, safe and economical driving.
- Drivers can refer to the maintenance plan for scheduled maintenance intervals, depending on the odometer reading or time interval, whichever comes first.
- For overdue maintenance items, the same time interval should be used for maintenance.
- Rubber hoses (for A/C and heating systems, braking systems, etc.) should be checked by professional technicians according to the maintenance schedule.
- These are particularly important maintenance items whose maintenance intervals are recorded in the maintenance schedule. Hoses with any degradation or damage should be replaced immediately.
- The maintenance schedule lists all the maintenance items that are necessary to keep the vehicle in optimum condition at all times.
- It is recommended that the maintenance be performed in accordance with the standards and specifications of BYD Auto Industry Co., Ltd., and by a local BYD authorized dealer or service provider.

- The maintenance schedule lists the maintenance items and travel time or distance based on the assumption that the vehicle is used as a normal means of transportation to carry passengers and goods that do not exceed the vehicle load limit.



CAUTION

- Please carry out regular maintenance of the vehicle according to the requirements in BYD Auto "Warranty and Maintenance Service Manual".

Maintenance Plan Requirements

The vehicle shall be maintained according to the regular maintenance schedule.

If the vehicle is operated primarily under one or more of the following special conditions, certain maintenance plan items may need to be performed more frequently.

- Road conditions
 - Driving on rough, muddy or slushy roads.
 - Driving on dusty roads.
- Driving conditions
 - Towed trailer, camping trailer or roof rack is used.

Maintenance Schedule

Vehicle maintenance is performed based on the mileages or months, whichever comes first.

Item	Interval
Chassis screws	Check it at three months or 5,000 km for the first time, at 12 months or 20,000 km for the second time, and every 12 months or 20,000 km afterwards. Replace damaged parts in a timely manner.
Brake pedal and EPB switch	Check them at three months or 5,000 km for the first time, at 24 months or 40,000 km for the second time, and every 24 months or 40,000 km afterwards. In severe driving conditions, check them at three months or 5,000 km for the first time, at 12 months or 20,000 km for the second time, and every 12 months or 20,000 km afterwards.
Brake friction block and disc	Check it at three months or 5,000 km for the first time, at 12 months or 20,000 km for the second time, and every 12 months or 20,000 km afterwards. Replace damaged parts in a timely manner.
Brake piping and hoses	Check them at three months or 5,000 km for the first time, at 24 months or 40,000 km for the second time, and every 24 months or 40,000 km afterwards. In severe driving conditions, check them at three months or 5,000 km for the first time, at 12 months or 20,000 km for the second time, and every 12 months or 20,000 km afterwards.
Guide pin of brake caliper assembly	Check it at 12 months or 20,000 km for the first time, and every 24 months or 40,000 km afterwards. Replace damaged parts in a timely manner.
Steering wheel and tie rod	Check them at three months or 5,000 km for the first time, at 24 months or 40,000 km for the second time, and every 24 months or 40,000 km afterwards. In severe driving conditions, check them at three months or 5,000 km for the first time, at 12 months or 20,000 km for the second time, and every 12 months or 20,000 km afterwards.
Drive shaft boot	Check them at three months or 5,000 km for the first time, at 24 months or 40,000 km for the second time, and every 24 months or 40,000 km afterwards. In severe driving conditions, check them at three months or 5,000 km for the first time, at 12 months or 20,000 km for the second time, and every 12 months or 20,000 km afterwards.
Ball pin and boot	Check them at three months or 5,000 km for the first time, at 24 months or 40,000 km for the second time, and every 24 months or 40,000 km afterwards. In severe driving conditions, check them at three months or 5,000 km for the first time, at 12 months or 20,000 km for the second time, and every 12 months or 20,000 km afterwards.

Item	Interval
Front and rear suspensions	Check them at three months or 5,000 km for the first time, at 24 months or 40,000 km for the second time, and every 24 months or 40,000 km afterwards. In severe driving conditions, check them at three months or 5,000 km for the first time, at 12 months or 20,000 km for the second time, and every 12 months or 20,000 km afterwards.
Tire condition and pressure, incl. TPMS	Check it at three months or 5,000 km for the first time, at 12 months or 20,000 km for the second time, and every 12 months or 20,000 km afterwards. Replace damaged parts in a timely manner.
Front and rear wheel alignment	Check them at three months or 5,000 km for the first time, at 24 months or 40,000 km for the second time, and every 24 months or 40,000 km afterwards. In severe driving conditions, check them at three months or 5,000 km for the first time, at 12 months or 20,000 km for the second time, and every 12 months or 20,000 km afterwards.
Tire rotation (Check tire pressure and condition at least once a month)	Check the tire pressure and conditions at least once a month and rotate tires every 10,000 km.
Door brake	Check it at three months or 5,000 km for the first time, at 12 months or 20,000 km for the second time, and every 12 months or 20,000 km afterwards. Remove dust from the tie rod with a wet soft cloth, apply 0.3-0.8 g grease to the tie rod, riveted joints, and rotating shaft, and replace damaged parts in a timely manner.
Wheel bearing clearance	Check them at three months or 5,000 km for the first time, at 24 months or 40,000 km for the second time, and every 24 months or 40,000 km afterwards. In severe driving conditions, check them at three months or 5,000 km for the first time, at 12 months or 20,000 km for the second time, and every 12 months or 20,000 km afterwards.
Coolant level in expansion tank	Check it at three months or 5,000 km for the first time, at 12 months or 20,000 km for the second time, and every 12 months or 20,000 km afterwards. Replace damaged parts in a timely manner.
Drive motor coolant	Replace the long-acting organic acid coolant every four years or 100,000 km, whichever comes first.
Brake fluid	Check it at three months or 5,000 km for the first time, at 12 months or 20,000 km for the second time, and every 12 months or 20,000 km afterwards. Replace damaged parts in a timely manner.

Item	Interval
Brake fluid	Replace it every two years or 40,000 km.
Vehicle module DTCs (to be cleared after recording)	Check it at three months or 5,000 km for the first time, at 12 months or 20,000 km for the second time, and every 12 months or 20,000 km afterwards. Replace damaged parts in a timely manner.
High-voltage battery tray, shield, impact bar, and mount point torque	Check it at three months or 5,000 km for the first time, at 12 months or 20,000 km for the second time, and every 12 months or 20,000 km afterwards. Replace damaged parts in a timely manner.
Battery pack capacity	Test and calibrate capacity every six months or 72,000 km.
Check and replace the gear oil and filter screen in the transmission (NT31 precursor asynchrony/NRT36 rear-guard transmission)	Replace them at 24 months or 40,000 km for the first time, and every 24 months or 48,000 km afterwards, the filter should also be replaced.
Powertrain leaks or bumps	Check it at three months or 5,000 km for the first time, at 12 months or 20,000 km for the second time, and every 12 months or 20,000 km afterwards. Replace damaged parts in a timely manner.
Loose high-voltage wiring harnesses and connectors	Check it at three months or 5,000 km for the first time, at 12 months or 20,000 km for the second time, and every 12 months or 20,000 km afterwards. Replace damaged parts in a timely manner.
Deformation of or oil stains on the high-voltage module	Check it at three months or 5,000 km for the first time, at 12 months or 20,000 km for the second time, and every 12 months or 20,000 km afterwards. Replace damaged parts in a timely manner.
Foreign materials on or ablation of charging connector	Check it at three months or 5,000 km for the first time, at 12 months or 20,000 km for the second time, and every 12 months or 20,000 km afterwards. Replace damaged parts in a timely manner.
HEPA filter*	Check it at three months or 5,000 km for the first time, at 12 months or 20,000 km for the second time, and every 12 months or 20,000 km afterwards, whichever comes first, and replace it if necessary. In severe driving conditions, check it every six months and replace it if necessary.
Lamp and LED lighting	Check it at three months or 5,000 km for the first time, at 12 months or 20,000 km for the second time, and every 12

Item	Interval
	months or 20,000 km afterwards. Replace damaged parts in a timely manner.
Headlight dimming	Check it at three months or 5,000 km for the first time, at 12 months or 20,000 km for the second time, and every 12 months or 20,000 km afterwards. Replace damaged parts in a timely manner.
Initial down tilt of low beam	Calibrate it every 10,000 km.
Foreign materials on or ablation of the EPS GND point	Check it at three months or 5,000 km for the first time, at 12 months or 20,000 km for the second time, and every 12 months or 20,000 km afterwards. Replace damaged parts in a timely manner.
EPS connector looseness and connector pin ablation	Check it at three months or 5,000 km for the first time, at 12 months or 20,000 km for the second time, and every 12 months or 20,000 km afterwards. Replace damaged parts in a timely manner.
EPS ECU corrosion	Check them at three months or 5,000 km for the first time, and every 24 months or 40,000 km afterwards. Replace damaged parts in a timely manner.
Foreign materials or corrosion on connections between the EPS ECU and motor*	Check it at three months or 5,000 km for the first time, at 12 months or 20,000 km for the second time, and every 12 months or 20,000 km afterwards. Replace damaged parts in a timely manner.
Vehicle module software update (update if any)	Check it at three months or 5,000 km for the first time, at 12 months or 20,000 km for the second time, and every 12 months or 20,000 km afterwards. Replace damaged parts in a timely manner.
Wading marks on high-voltage parts	Check it at three months or 5,000 km for the first time, at 12 months or 20,000 km for the second time, and every 12 months or 20,000 km afterwards. Replace damaged parts in a timely manner.
Lock nut torque of wiper arm	Check it at three months or 5,000 km for the first time, at 12 months or 20,000 km for the second time, and every 12 months or 20,000 km afterwards. Replace damaged parts in a timely manner.
Abrasion of shock absorber sleeve on hood hinge limit stud	Check it at three months or 5,000 km for the first time, at 12 months or 20,000 km for the second time, and every 12 months or 20,000 km afterwards. Replace damaged parts in a timely manner.
Hood lock and fasteners	Check them every 12 months.

Note: When checking Item 1, replace chassis parts in a timely manner if any abnormal damage is found.

REMINDER

- To keep the high-voltage battery in optimal condition, please fully charge and discharge the vehicle regularly (at least every six months or 72,000 km, whichever comes first) for battery self-calibration. You can also contact a BYD authorized dealer or service provider for capacity testing and calibration.

Severe driving conditions include:

- Frequent driving in dusty areas or frequent exposure to salt-laden air.
- Frequent driving on bumpy, puddled, or mountain roads.
- Frequent driving in cold weather.
- Frequent and sudden braking.
- Frequent use of a towed trailer.
- Use as a taxi.
- Driving in congested urban areas at temperatures above 32°C for more than 50% of total travel time.
- Driving at speeds over 120 km/h at temperatures above 30°C for more than 50% of total travel time.
- Frequent overloading.

Regular Maintenance

Regular Maintenance

- Be sure to maintain the vehicle as per the maintenance schedule to allow it to serve in the best working efficiency and reduce fault occurrence.
- Drivers can refer to the maintenance plan for scheduled maintenance intervals, depending on the odometer reading or time interval, whichever comes first.
- For overdue maintenance items, the same time interval should be used for maintenance.
- It is recommended that the maintenance be performed in accordance with the standards and specifications of BYD Auto Industry Co., Ltd., and by a local BYD authorized dealer or service provider.
- The maintenance schedule lists the maintenance items and travel time or distance based on the assumption that the vehicle is used as a normal means of transportation to carry passengers and goods that do not exceed the vehicle load limit.



CAUTION

- Please maintain the vehicle regularly according to the requirements in the Warranty and Maintenance Service Manual of BYD.

Vehicle Corrosion Prevention

The most common causes of vehicle corrosion are:

- The underbody of the vehicle is covered in salt, dust or moisture.
- The vehicle or some of its parts are exposed to high humidity and high temperature for a long time.
- The paint layer or underlayer is scratched by minor collision or by stones and gravel.

The following rules should be observed to prevent vehicle corrosion:

- Wash the vehicle frequently.
 - If driving on saline roads in winter or living in coastal areas, wash the landing area of the vehicle at least once a month, and clean the chassis and hubcap with a high-pressure water jet or steam to reduce corrosion. Wash the chassis thoroughly after winter.
- Check body paint and trims.
 - Any chip or crack found on the paint must be repaired immediately to prevent corrosion. If fragments or cracks peel off from the metal surface, it is recommended to go to a BYD authorized dealer or service provider for repair.
- Check cabin interior.
 - Moisture and dust buildup under the carpet can cause corrosion. Check the undersides of carpets frequently to make sure these areas are dry.
 - Special care should be taken when transporting chemicals, detergents, fertilizers, salt, and other substances, and such substances should be kept in appropriate containers for

transportation. If spillage or leakage is found, clean immediately and keep dry.

- Use fenders.
 - Fenders can protect vehicles in saline areas or on gravel roads. The bigger and closer to the ground the fender, the better.
- Park in a well-ventilated and dry area.

Paint Maintenance Tips

- Do not perform secondary painting if there is no obvious scratch on the finish, so as to prevent mismatch or color incompatibility.
- When the vehicle is not used for a long period, it should be parked in a garage or a well-ventilated place, and special body cover should be used in winter. Choose a shady place for parking temporarily.
- Prevent strong impacts, knocks, or scratches on the paint. If the paint is scratched, dented or if it peels, it should be repaired in time, preferably by professional auto beauty provider.
- Do not touch the paint with a greasy hand or cloth. Do not place greasy tools or rub with organic solvents on the vehicle body so as to avoid chemical reactions.
- The vehicle must be waxed once a month or whenever water resistance performance of the vehicle degrades and be taken to an auto beauty provider for maintenance once every three months.
- High quality polish and wax must be used. If body finish is severely weathered, use a car cleaning polish in addition to the wax. Carefully follow the manufacturer's instructions and precautions. Chrome finish should be

polished and waxed as well as painted finish.

 **CAUTION**

- When the vehicle is repainted and placed in a high-temperature paint waxing workshop, the vehicle's plastic bumper must be removed to avoid damage caused by high temperatures.

Vehicle Cleaning

- The vehicle must be cleaned in time under the following circumstances which will cause peeling of paint layer or corrosion of body and parts:
 - Driving along the coast.
 - Driving on a road on which anti-freeze has been scattered.
 - Driving on roads covered with coal tar.
 - Resin, bird droppings and insect carcasses get stuck.
 - Driving in areas with a large amount of smoke, soot, dust, iron filings or chemicals.
 - Vehicles visibly soiled by dust or mud.
 - After raining.

Manual Vehicle Washing

Before washing the vehicle, park it in the shade, and wait for the vehicle to cool down sufficiently.

1. Hose off loose dirt, including all muds or road salts at the bottom of the vehicle and on wheel pits.
2. Wash the vehicle with neutral agents, the mixing of which should be carried out according to the manufacturer's

instructions. Soak a soft cloth with cleaning solution and gently wipe it down along the direction of the water flow. Do not wipe in a circular motion or horizontally.

3. Rinse well—Dried washing agent forms markings. After washing the vehicle in hot weather, rinse all parts properly.
4. Dry the vehicle with a clean soft towel to prevent stay water marks. In order to prevent scratching, do not rub or apply excessive force on the paint.

 **REMINDER**

- Do not use alkaline washing powder, soapy water, dishwashing liquid, dewaxing detergent, or volatile solvents.
- When cleaning the light assemblies, do not wipe the surface of the combination lights with chemical solvents, such as gasoline, alcohol, lacquer thinner, paint thinner or carbon tetrachloride; otherwise, cracks will appear on the assembly guards.
- Vehicles driven in coastal areas or in heavily polluted areas should be rinsed every day.
- Do not scrape or use gasoline to remove dirt. The plastic wheel trims are easily damaged by organic matter. If any organic matter is splashed on the trims, it must be washed off with water and the trims must be checked for damage. If necessary, promptly replace plastic wheel trims that have been seriously damaged. Otherwise, they may fly off while the vehicle is in motion.



REMINDER

- Do not wash the bumper with cleaning agents that contain abrasives.
- The plated metal parts must be cleaned with a carbon cleaning agent, and waxed regularly for protection.

Automatic Vehicle Washing

When choosing an automated car wash service, be aware of certain types of brushes, unfiltered rinsing water, or machine-specific rinsing procedures that may scratch the paint and affect its gloss and durability, especially darker colors. Before washing the vehicle, it is best to consult the staff of the car wash service provider to understand which washing procedures are the safest for the paint finish.

Interior Cleaning



REMINDER

- Prevent direct water splashes onto the dashboard or floor when washing the vehicle, as these may cause electrical faults.
- Do not wash the vehicle's floor.

Carpet

- Clean carpets with a good foam detergent.
- Use a vacuum cleaner to remove as much dust as possible. Several types of foam detergents can be used. Some are in spray cans, and the others are powders or liquids, which produce foam when mixed with water. Clean the carpets with foam soaked sponge

or a brush, scrubbing in a circular motion.

- Do not use plain water, and keep the carpets as dry as possible.

Seat Belts

- The seat belts can be cleaned with neutral soapy water or lukewarm water.
- Scrub the seat belts with a sponge or soft cloth. Check the seat belts for excessive wear, tear or cut marks.



CAUTION

- Do not clean the seat belts with stain remover or bleach, so as not to weaken them.
- Do not use the seat belts until they are dry.

Doors and Windows

- Doors and windows can be cleaned with any ordinary detergent.
- Check the door checks regularly. If the check lever is found with visible dust accumulation, wipe it with a wet soft cloth.



CAUTION

- When cleaning the inside of the rear window, be careful not to scratch or damage the heating wire and the connector.

A/C Control Panel, Car Speakers, Dashboard, Control Panel and Switches

- Clean the A/C control panel, car speakers, dashboard, control panel and switches with a wet soft cloth.

- Wipe dust off gently with a clean soft cloth soaked in lukewarm water.

 **CAUTION**

- Do not use organic substances (solvents, kerosene, alcohol, gasoline, etc.) or acid and alkali solutions. These chemicals can cause discoloration, staining or flaking.
- If any detergent or polishing product is used, make sure they do not contain any of these ingredients.
- If a new liquid washing agent is used, it must not come into contact with the vehicle's interior surfaces, as it may contain any of the previously mentioned ingredients. If there is any spillage, immediately clean it thoroughly.

Leather

- Leather trimmings can be cleaned with a neutral detergent for woolen.
- Use a soft cloth with a neutral detergent solution to wipe off the dust, and then use a clean, wet cloth to wipe the remaining detergent thoroughly.
- If leather gets wet, wipe it with a clean soft cloth and let it dry in a cool, ventilated place.
- For any questions about vehicle cleaning, please consult a local BYD authorized dealer or service provider.

 **CAUTION**

- If dirt cannot be cleaned off using a neutral detergent, clean it with a detergent that does not contain organic solvents.

 **CAUTION**

- Do not clean leather with any organic material such as volatile oil, alcohol, gasoline, acid or alkali, as these will cause discoloration.
- Do not clean leather with a nylon brush or synthetic fiber cloth, as these may scratch the fine patterns on the leather surface.
- Mold may grow on dirty leather trimmings. Special care must be taken to avoid oil stains, and atrimmings must always be kept clean.
- Prolonged exposure to sunlight will cause leather to harden or shrink, so the vehicle should be parked in a shady and cool place, especially in the summer.
- In hot weather, avoid placing vinyl or waxy items on the trimmings, as these may stick to leather in high temperatures.
- Improper cleaning of leather trimmings may cause discoloration or spots.

Self-Maintenance

Self-Maintenance

Self-Maintenance Precautions

- If maintenance is to be carried out by the owner, be sure to follow the correct steps specified in this section.
- Note that improper and incomplete maintenance will affect the good use of the vehicle.

- This section only lists instructions on simple maintenance items that can be done by the owner. However, there are many items that must be done by qualified technicians with special tools.
- Special care must be taken in maintaining vehicles to prevent accidental injuries. Make sure to obey the followings:

 **CAUTION**

- Some vehicle circuits and parts carry high current or high voltage. Beware.
- If refrigerant spills out, wipe it clean with a dry cloth or paper to prevent damage to parts or painted surfaces.
- If brake fluid spills out, rinse it with water to prevent damage to parts or painted surfaces.
- When replacing wiper blades, prevent them from scratching the glass surface.
- Before closing the hood, make sure there are no tools, cloths, etc., left inside.
- Goggles are to be worn whenever work is done under the vehicle, to prevent objects or liquids from falling into eyes.
- As brake fluid can damage the skin or eyes, caution should be exercised while filling the brake fluid. If brake fluid splashes on skin or eyes, wash immediately with plenty water. If discomfort persists, seek medical attention.

Checks

The following items should be checked according to usage or specified mileage:

- Coolant level - Expansion tank coolant level should be checked at each charge.
- Windshield washer fluid - The residual amount of washer liquid in the tank should be checked monthly. When washer liquid is frequently used, the residual amount of liquid should be checked at each charge.
- Windshield wiper - Check the wiper condition monthly. If the wiper does not work, check it for wear, cracking or other damage.
- Brake fluid level - Check the level monthly.
- Brake pedal - Check whether the brake pedal is operating properly.
- EPB switch - Check whether the switch is functional.
- Iron Starter Battery battery - Check the battery and terminals condition for corrosion monthly.
- A/C system - Check the operation of A/C units weekly.
- Tires - Check tire pressure monthly. Check tread wear and whether there are foreign bodies embedded.
- Windshield defroster - Check the defroster vent monthly.
- Lights - Check the condition of headlights, position lights, tail lights, high mount brake light, turn signals, rear fog lights, brake lights and license plate light monthly.
- Doors - Check whether the trunk lid and all other doors (including rear doors) can be opened freely and locked securely.
- Horn - Check whether the horn is functioning properly.

REMINDER

- There is risk of damage or accidents if the vehicle is driven for long periods without inspection.

Combination Lights

Front Combination Lights Adjustment

- Headlights are aligned before vehicle delivery. If the vehicle carries heavy load frequently, headlights may need to be realigned. It is recommended to have the headlights aligned by a BYD authorized dealer or service provider.

Fogging of Lights

- Combination lights, tail lights, and turn signals on the side mirrors may become foggy after heavy rain or cleaning. This is similar to the condensation on the side window when it rains. It does not mean any problem with your vehicle.
- The lights are a relatively enclosed and narrow space. The temperature is very high when they light up (the mask and reflector could be burned and deformed easily), so they need heat dissipation. There are heat dissipation holes on the lamp housing for convection. The greater the temperature difference is, the more active the convection is. During the convection, the moisture in the air inevitably enters a lamp. Factors such as exposure to sunlight, convection, and bulb heating easily cause the moisture in the air to condense into fog or water beads on the lamp surface at low temperatures. This is called headlight fog.

REMINDER

- If fog presents inside the combination lights and inside the turn signal on the external rearview mirror, it may be due to high air humidity or significant temperature difference between the vehicle and its surroundings. In that case, turn on the combination lights or turn signal while driving. The fog will evaporate after a short period of driving.
- If there is significant water accumulation inside the lights, it is recommended to drive the vehicle to a BYD authorized dealer or service provider for maintenance.

Vehicle Storage

- If the vehicle needs to be parked for a long time (more than a month), the following preparations should be made. Proper preparation helps prevent degradation and ensure easy reuse of the vehicle. If possible, park the vehicle indoors.
- Charge the vehicle on time.
- Thoroughly clean and dry the body surface.
- Clean the interior of the vehicle to ensure that carpets and mats are completely dry.
- Release the parking brake and set the gearshift lever in parking gear.
- Open one window slightly (if the vehicle is stored indoors).
- Disconnect the 12V battery's negative terminal.

- Pad the front wiper arm with a folded towel or cloth to keep it out of contact with the windshield.
- To reduce adhesion, apply silicone lubricant to all door seals and body wax to the painted surface where the door seals meet.
- Cover the body with a breathable covering made of a "porous material" such as cotton. Non-porous materials, such as plastic sheeting, can build up moisture and damage the paint.
- If possible, start the vehicle regularly (preferably monthly). If the vehicle has been parked for a year or more, go to a BYD authorized dealer or service provider for comprehensive maintenance.

Hood

Opening the Hood

1. Pull the handle on the right under the dashboard twice. The hood unlocks and opens slightly.

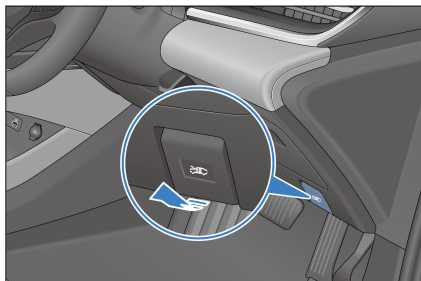

2. To open the hood:
 - Raise the hood to an appropriate height; then it will automatically rise to the open state.



3. To close the hood:
 - Pull down the hood, and press it with force by hand to close it.

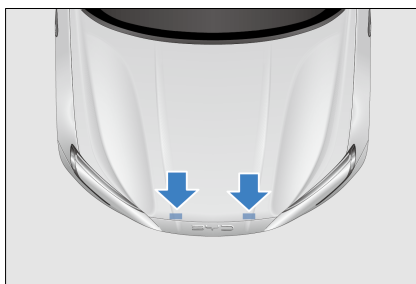

4. After closing the hood, check whether the latch is securely locked.

! REMINDER

- Confirm that the hood is closed and locked securely. Otherwise, while driving, the hood may suddenly open and cause an accident.

Cooling System

- It is required that the liquid level should be between the Maximum(MAX) and Minimum(MIN) marker lines of the coolant expansion tank.
- The coolant should always be of the same specification as the original refrigerant, without adding

any mixture. Different brands and types of coolant should not be mixed.



- If the level is below the MIN line, coolant should be refilled to the MAX line. Check the cooling system for leakage.

REMINDER

- Opening the coolant expansion tank when the motor has not yet fully cooled down may cause coolant to squirt out, resulting in severe burns.

CAUTION

- Do not add any rust inhibitor or other additives to the cooling system. This is because these additives may be incompatible with the coolant or motor components.
- Before opening the coolant expansion tank, verify that the motor, high-voltage electrical control integration module, coolant expansion tank cap and the radiator have cooled down.

Braking System

- Check the level in the fluid tank monthly, and change the brake fluid according to the travel time and

mileage specified in Maintenance Schedule.

- Be sure to use the brake fluid of the same specifications as the original brake fluid, and different types of brake fluid should not be mixed.
- It is required that the level in the fluid tank should be between "MAX" (maximum level) and "MIN" (minimum level) marks.
- If the level is below the MIN mark, check if the braking system leaks and the brake friction blocks are worn.



Washer

- During normal use, check the liquid level of the windshield washer reservoir at least monthly.
- If the windshield washer is used frequently, the level of the washer reservoir should be checked more frequently.
- High quality windshield washer fluid should be added to improve stain removal and prevent freezing in cold weather.

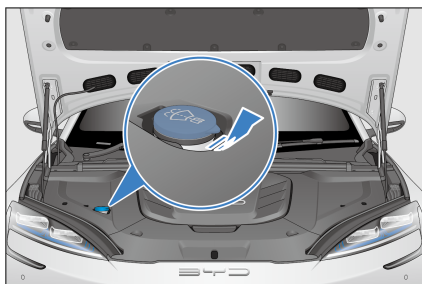

- When refilling the washer fluid, use a clean cloth dipped in the windshield washer fluid to clean the windshield wiper blade, thus helping keep the wiper blade in good condition.

CAUTION

- Do not inject vinegar-water solution into the windshield washer fluid reservoir.
- It is recommended to use certified windshield washing fluid.

A/C System

- The A/C system is a closed system, and any important maintenance work should be performed by professionals from a BYD authorized dealer or service provider.
- Owners can perform the following operations to ensure that the A/C system works effectively.
 - Check the radiator and A/C condenser regularly.
 - Remove leaves, insects, and dust - which can block airflow and reduce cooling - from the front surface.
 - In cold months, the A/C should be turned on at least once a week for at least 10 minutes each time, to allow the circulation of lubricating oil contained in the refrigerant.

- If A/C efficiency decreases, go to a BYD authorized dealer or service provider for maintenance.

CAUTION

- Whenever the A/C system is inspected and repaired, the maintenance station should be required to ensure the use of refrigerant recirculation equipment. This equipment can recover refrigerant for reuse. Improper disposal of refrigerant pollutes the environment.

Wiper Blades

The blade strip, made of synthetic rubber, is a vulnerable part. Various service environment of the vehicle and usage habits of drivers can damage the blades. Therefore, please observe the following to ensure the service life of blades and driving safety:

- Do not use a blade to remove ice from the windshield surface. Use a customized ice scraper.
- Do not scrape the windshield surface if it is dirty, greasy or waxy.
- Keep the windshield surface clean. Do not scrape dust, sand, insects, or foreign bodies on the windshield surface.
- During vehicle washing and body paint maintenance, there is no need to wax the windshield, as the wax layer reflects light in bad light, affecting the line of sight and driving safety. After washing the vehicle, rinse the blade with plain water, and use special windshield wax cleaner to remove the wax layer on the windshield.
- Do not wash the blades directly with a water jet to prevent excessive water pressure from damaging the blades.

Maintenance Rules

- Clean windshield and blade regularly (preferably once a week or once every two weeks).
- Wipe the wiper regularly (preferably once a day or once every two days). When using a blade to wipe the windshield, keep the windshield fully wet (when there is no rain, the washer liquid must be sprayed in advance).
- Clean the windshield with a special windshield washer fluid.
- Promptly clean mud and insect carcasses stuck to the windshield with a rag.
- When there are marks on the windshield caused by gravel, maintenance should be carried out timely (it is recommended that windshield repair resin products should be used and the windshield should be replaced if marks are too large or too many.)
- Replace the wiper blades regularly, preferably once every six months.
- When cleaning the windshield, raise the wiper arm in advance. The specific operation method is as follows:
 1. Go to infotainment system and tap Vehicle health → Maintenance to enable front wiper maintenance. The wiper is rotated down.
 2. Grasp the upper end of the wiper arm and carefully lift the wiper arm and blade assembly.

Tires

- For safe driving, tires must be made and sized to fit the vehicle, with good tread and standard tire pressure.

- The following pages provide details on how to check tire pressure, damage to and wear of tires, and the operating method for tire transposition.

WARNING

- Using excessively worn tires, or with too high or low pressure, poses a high risk of accidents.
- Follow all of the instructions in this manual on tire inflation and maintenance.

Tire Inflation

- Keep tires properly inflated to provide the best combination of maneuverability, tread life and driving comfort.
- Under-inflated tires can cause uneven tire wear, affect steerability and energy consumption, and are prone to leakage due to overheating.
- Over-inflated tires reduce riding comfort and are prone to damage from uneven roads. In severe cases, the risk of tire bursting poses severe threats to the safety of the entire vehicle. Over-inflation will also cause uneven wear and tear of tires, affecting tire service life.
- When tires are cold, you can decide whether to replenish tire pressure according to the tire pressure values displayed on the instrument cluster.
- Tire pressure should be measured while tires are at ambient temperatures. This means that it should be measured at least three hours after stop. If you must drive the vehicle before the tire pressure is measured, tires can still be considered at ambient temperatures as long as the travelled distance is not more than 1.6 km.

- It is normal that tire pressure reading measured while tires are hot (after travel of several kilometers) is 30-40 kPa (0.3-0.4 bar) higher than when tires are cold. In that case, do not deflate tires in order to achieve the specified cold tire pressure reading; otherwise, the tire pressure will be insufficient.

! REMINDER

- The recommended tire pressure label (stuck on the driver's side door frame) indicates the recommended cold tire pressure.
- Tubeless tires have a self-sealing function when they are punctured. However, as the leak is usually very slow, as soon as the tire begins to depressurize, carefully look for the leak location.

Checks

- Whenever checking tire inflation, check tires for damage, foreign body piercing and wear.
 - Replace the tire if bumps, or tread or side damage are found. Tires should be replaced if any of the case happens.
 - Replace the tire if there are cracks on its side, or if its fabric or cord can be seen.
 - Replace tires with excessive tread wear.

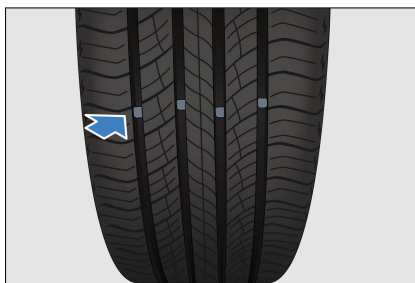

- Tire treads are cast with wear bars. When the tread is even with the wear bar, its thickness is less than 1.6 mm. The adhesion of tires worn to this extent is very small on wet roads.
- Tyres with exposed wear bars are experiencing serious performance loss and therefore must be replaced.

Maintenance

- In addition to proper inflation, proper wheel alignment also helps reduce tread wear.
- If uneven tire wear is found, go to a BYD authorized dealer or service provider and check the wheel alignment.
- The vehicle has been balanced in the factory, but tires need to be re-balanced after driving for a period of time.
- If there is some kind of continuous vibration while driving at high speeds (above 80 km/h), but not at low speeds, go to a BYD authorized dealer or service provider and check the tires.
- If a tire has been repaired, be sure to re-balance it.
- When installing a new tire or replacing a new wheel, always perform tire balancing.



CAUTION

- Improper wheel balancers will get stuck, become loose and fall off. While driving, this will damage the car or surrounding objects.
- Improper wheel balancers will damage the aluminum rims of the vehicle. Therefore, it is recommended to use original wheel balancers.

Tire Rotation

- In order to make tires wear the same and prolong their service life, it is recommended to rotate tires every 10,000km and conduct four-wheel alignment, inspection and adjustment as well.
- When purchasing replacement tires, you may find that some tires are "directional", which can only be rotated in one direction. If directional tires are used, only the front and rear wheels can be swapped in tire rotation.

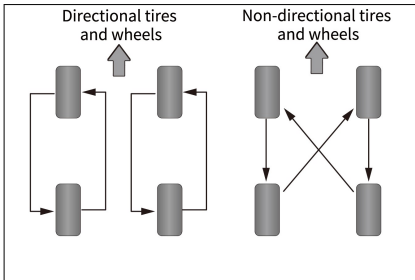

Tire and Wheel Replacement

- Original tires maximize performance, while providing the best combination of maneuverability, driving comfort and service life.
- Go to a BYD authorized dealer or service provider for replacement of original tires.

- Replacement of tires with different sizes, road ranges, rated speeds and maximum cold pressures (marked on the tire side) or mixed use of radial tires and diagonal tires can reduce braking ability, driving force (ground adhesion) and steering accuracy.
- The installation of unsuitable tires can affect the maneuverability and stability of the vehicle, and may lead to accidents.
- It is best to replace all four tires at once. Do not replace only one tire; otherwise it will seriously affect the maneuverability of the vehicle.
- ABS works by comparing wheel speed. When replacing a tire, use a tire of the same size as the original tire. The size and structure of the tire can affect wheel speed and may lead to uncoordinated system operation.
- If the wheel needs to be replaced, ensure that the specifications of the new wheel match those of the original wheel. New wheels are available for purchase at a BYD authorized dealer or service provider. Please consult a BYD authorized dealer or service provider before replacing the wheels.



REMINDER

Observe the following instructions, otherwise it will lead to typical handling hazards, which will cause the vehicle to lose control.

- Do not mix radial tires, bias belted tires or diagonal ply tires.
- Only use the tire sizes recommended by the manufacturer.

Fuses

All vehicle circuits are provided with fuses to prevent short circuit or overloading. These fuses are mounted in the under-hood power distribution box (PDB), dashboard PDB, positive terminal PDB and rear compartment PDB, respectively. Fuse labels are included in the under-hood and dashboard PDBs, showing the correspondence of fuses with electrical components.

① Under-hood PDB

② Dashboard PDB

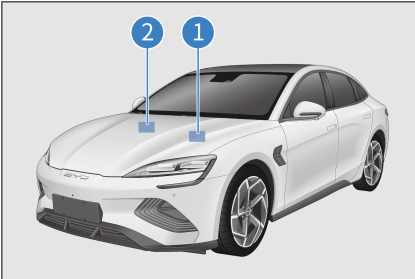

- The fuses under the hood are located at the left rear part in the engine

compartment. To open the PDB, remove the compartment trim panel at first, and then just press the lock latch.

- Dashboard fuses under the driver's seat are on the left of the dashboard, take apart the lower body of the dashboard to check the fuses.
- Replacement of blown fuses with ones of higher amperage can significantly increase the likelihood of damage to the electrical system.
- If there is no spare fuse of the same amperage, use a fuse with lower amperage instead.

! REMINDER

- Do not use a fuse with a higher rated ampere value, or any other solution to replace the fuse, as this may cause serious damage or even a fire.
- If a fuse blows, go to a BYD authorized dealer or service provider for inspection or replacement.

Under-Hood PDB Nameplate

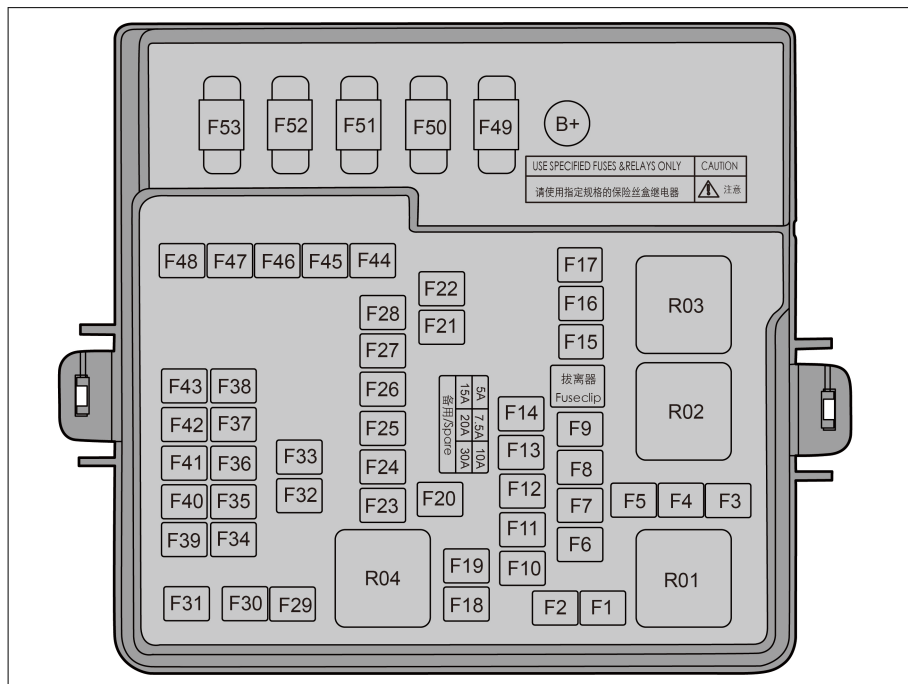

No.	Ampere (A)	Protected Component or Circuit
F1	-	-
F2	25	External amplifier
F3	-	-
F4	-	-
F5	-	-
F6	-	-
F7	-	-
F8	-	-
F9	7.5	Battery manager
F10	15	Electrically controlled cooling water pump
F11	10	Electrically controlled cooling water pump
F12	-	-

No.	Ampere (A)	Protected Component or Circuit
F13	-	-
F14	-	-
F15	10	ADAS
F16	40	Low speed fan
F17	-	-
F18	-	-
F19	-	-
F20	20	Trailer controller
F21	30	Front wiper
F22	30	Rear windshield defroster
F23	20	Rear electronic fuel pump
F24	10	Compressor
F25	10	Motor controller
F26	7.5	E-Call
F27	15	Auxiliary power
F28	15	USB
F29	30	Left front electric seat
F30	60	ESC
F31	20	Front electronic fuel pump
F32	30	Right front electric seat
F33	10	Integrated thermal management module
F34	15	Heater
F35	5	Rear body controller
F36	10	ADAS
F37	7.5	ADAS
F38	10	SRS
F39	-	-
F40	7.5	ETC

No.	Ampere (A)	Protected Component or Circuit
F41	5	EPS
F42	5	ESC
F43	7.5	Suspension module
F44	60	ESC
F45	40	Blower
F46	15	USB
F47	-	-
F48	-	-
F49	125	DP-EPS
F50	-	-
F51	60	Electric fan
F52	-	-
F53	-	-

Dashboard PDB Nameplate

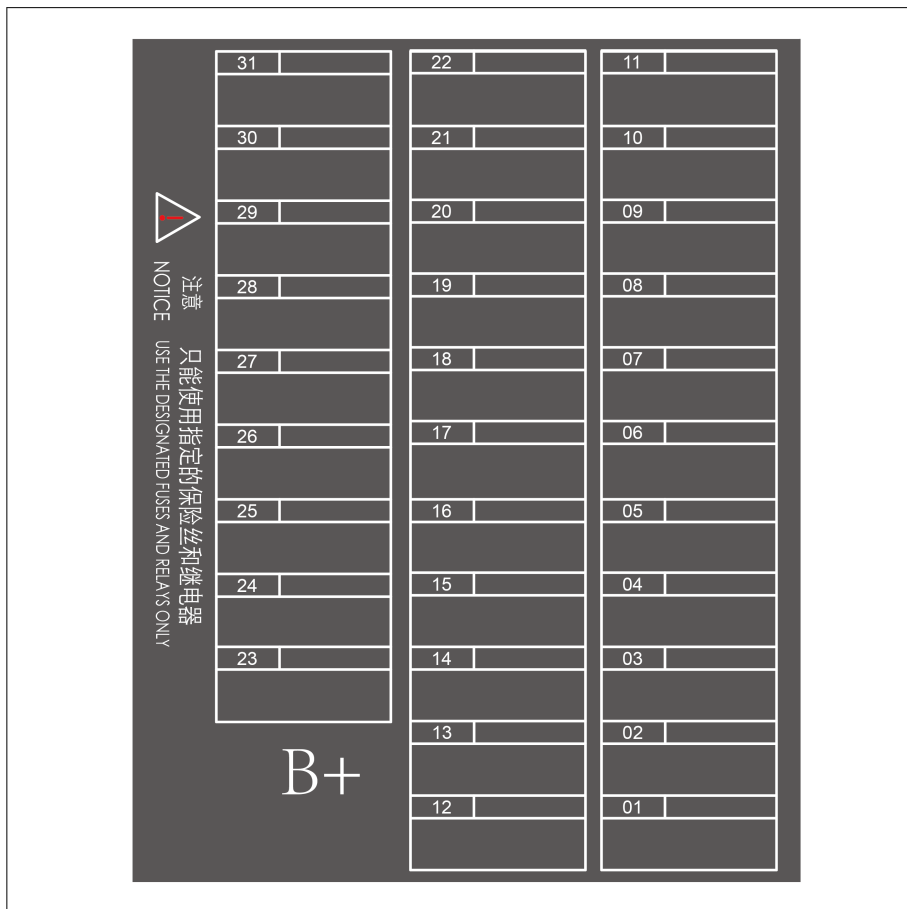

No.	Ampere (A)	Protected Component or Circuit
01	30	Rear body controller
02	30	Rear body controller
03	10	Wireless charger
04	10	Diagnosis port
05	7.5	HUD
06	5	High-frequency reception module
07	5	Gearshift panel

No.	Ampere (A)	Protected Component or Circuit
08	20\15	Infotainment system
09	5	Brake light switch
10	30	Rear body controller
11	7.5	Combination switch
12	30	Constant power
13	25	External amplifier
14	30	Intelligent driving
15	30	Intelligent driving
16	15	High voltage all in one
17	15	High voltage all in one
18	15\25	Suspension module
19	25	Left front window
20	25	Right front window
21	25	Left rear window
22	25	Right rear window
23	15	CCS communication converter
24	10	Alcohol Interlock
25	1.5	E-Call
26	-	-
27	-	-
28	-	-
29	-	-
30	-	-
31	-	-

 **REMINDER**

- Different vehicle configurations have different fuse amperages (such as infotainment).

 **REMINDER**

Maintenance and replacement should be based on the actual object.

07

WHEN FAULTS OCCUR

When Faults Occur.....188

When Faults Occur

Reflective Vest

! REMINDER

- If the vehicle breaks down and needs to stop in an emergency, please wear the reflective vest equipped with the vehicle in time.

If Smart Key Battery Is Exhausted

If the smart key indicator does not flash and the vehicle cannot be started using the start function, the smart key battery may be exhausted. It is recommended to contact a BYD authorized dealer or service provider for inspection as soon as possible. In this case, you may start the vehicle in no power mode.

! CAUTION

- Do not place keys in areas at high temperature.
- Do not hit or slam the key with hard objects.
- Keep the key away from the magnetic field.
- When the door is locked and entering the anti-theft state, if you are using the vehicle, keep the key away from the vehicle because the automatic card finding of the vehicle will consume the low-voltage battery.

1. Use the mechanical key to unlock the vehicle.
2. Press the brake pedal and the START/STOP button. The smart key warning

light comes on and the speaker in the vehicle gives a beep.

3. Keep the smart key close to the no-power mode sign on the auxiliary dashboard within 30 seconds after the speaker beeps. The speaker beeps again, the smart key warning light turns out, and the vehicle can be started.

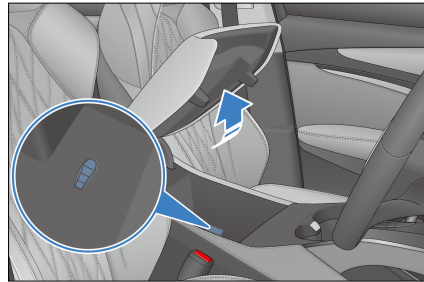

- The no-power mode sign is located in the cubby box.
4. Start the vehicle within five seconds after the speaker beeps again.

Emergency Shutdown System

- If the following conditions are met, the emergency shutdown system will be activated and the HV system will shut down automatically:
 - Any air bag fails to deploy after a front collision.
 - Rear collision.
 - Vehicle system failure.
- If any of the above collisions and vehicle system failures occur, the OK indicator goes off.
- Activating the emergency shutdown system in the noted types of collision can minimize the risks leading to injuries or accidents.

- Once the emergency shutdown system is activated, the vehicle system cannot be switched into OK status. In that case, contact a BYD authorized dealer or service provider for help. Even if the ignition switch is set to the OK position, the system will be turned off immediately. Contact a BYD authorized dealer or service provider as soon as possible.

Vehicle Fire Rescue

In case of fire, continue to operate the vehicle as follows according to the actual situation:

1. Switch the ignition off, and leave the vehicle.
2. On the precondition that personal safety is ensured, if the fire is small and slow, use a dry powder fire extinguisher to put out the fire, and call for help immediately.
3. If the fire is large and growing quickly, stay away from the vehicle and wait for rescue.

CAUTION

- Wear insulated gloves; Use the specified type of fire extinguisher. Using water or an incorrect fire extinguisher to extinguish the fire may result in electric shock.
- In the case of special circumstances resulting in flying projectiles (such as interior trimming parts, glass, etc.) stay away from the vehicle. Contact a BYD authorized dealer or service provider to go to the site to deal with it.

Battery Leakage Rescue

After a collision, if there is battery leakage, an acrid smell inside the vehicle, visible acid flow outside the vehicle, or any smoke with the battery pack:

1. Switch the ignition off, and disconnect the starter iron battery under the hood if conditions permit.
2. It is recommended to call immediately a BYD authorized dealer or service provider for rescue.

If a Collision Occurs

In case of collision, operate the vehicle as follows according to the actual situation:

1. Switch the ignition off, and disconnect the starter iron battery under the hood if conditions permit.
2. Call immediately a BYD authorized dealer or service provider for rescue.
3. Carry out a simple inspection, if conditions permit: Check whether any edge of the high-voltage battery tray is cracked and whether any obvious liquid flows out.
 - If skin comes in contact with leaked fluid, wash it immediately with plenty of water for 10-15 minutes. If there is still any discomfort, apply 2.5% calcium gluconate ointment, or soak in 2% to 2.5% calcium gluconate solution. If the condition does not get better or discomfort persists, seek medical help immediately.

WARNING

- Do not touch the leaked fluid. Stay away from the vehicle.
- Do not dispose of the leaked fluid in water or soil.

⚠ WARNING

- This vehicle uses high voltage DC power supply. The system can generate high heat before and after the vehicle is started or powered off. Beware of high temperatures.
- Do not disassemble, move, or change any high voltage battery part or connecting wire, as the connector can cause serious burns or electric shock. The orange cables are part of the high voltage harness. Users must not repair the high voltage system by themselves. If any repair is required, go to a BYD authorized dealer or service provider for repair.
- The remote control key and high voltage components may harm personnel carrying medical devices.

If the Vehicle Needs Towing

If the vehicle needs towing, it is recommended to contact a BYD authorized dealer or service provider, a professional towing service or the organization you joined for roadside assistance.

⚠ CAUTION

- Do not allow other vehicles to pull your car with only ropes or chains.

Most common towing methods:

- Flatbed device
 - When the vehicle is faulty and needs towing, a flatbed trailer is the best choice. This is because leaving a

single front or rear wheel on the ground can cause damage to high voltage components, and leaving a single front or rear wheel of the vehicle in power-up mode on the ground can cause loss of driver assistance system sensor calibration.

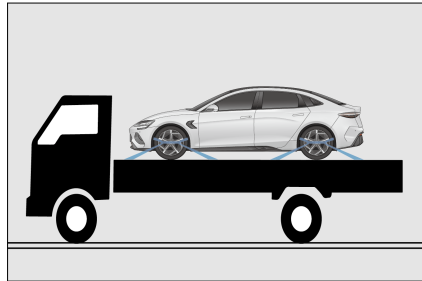

Tow Hook

The installation point of vehicle tow eye is shown in the illustration.

1. Press to start.
2. Install the tow hook in the tow hole.



⚠ CAUTION

- Towing the vehicle with a towing hook is not recommended. You'd better contact a professional towing service or the organization you joined for roadside assistance.
- Only the in-vehicle towing hook can be used. Otherwise, your vehicle will be damaged.



CAUTION

- Do not tow the vehicle from the rear with four wheels staying on the ground, to avoid damage to the vehicle.

If a Tire Goes Flat

- Maintain the lane position and gradually slow down the vehicle. Drive the vehicle off the busy road to a safe place. Park on solid, flat ground and avoid highway forks. Park on solid, flat ground.
- Please refer to the followings to operate when parking:
 1. Depress the brake pedal to stop the vehicle smoothly, and then press the P button to switch to P mode. In such case, the P gear indicator on the instrument cluster goes on.
 2. Press START/STOP button.
 - Power off the vehicle and turn on the hazard warning light.
 - Be sure to have all passengers get off the vehicle and ask them to go to a safe place away from crowded traffic.
 - To prevent slipping, secure the vehicle by wedging the tire diagonally against the flat tire.



CAUTION

- Do not continue driving with a flat tire. Driving even a short distance can cause too severe damage for the tire to be repaired.

In-Vehicle Tools

- These tools are stored in a tool box under the trunk cover flap.

- ① Warning triangle
- ② Reflective vest
- ③ Lug nut cover removal clamp
- ④ Using tire repair device
- ⑤ Tow hook

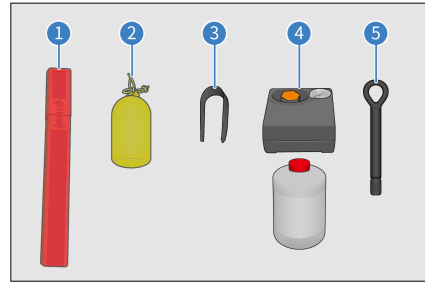

- In an emergency where you need to service the vehicle yourself, you must know how to use these in-vehicle tools and their locations.

Placing the Warning Triangle



REMINDER

- Before repairing the vehicle while stopped on a public road, remember to place a warning triangle in the lane where your vehicle is located, 100-200 m behind the vehicle, red side facing vehicles oncoming from behind, in order to warn them and prevent accidents. After the repair, recover the warning triangle for future use.

The warning triangle is used to warn drivers of vehicles coming from behind and to avoid risk of collision with the vehicle ahead being parked or repaired due to high speed or late braking.

How to use the warning triangle:

1. Take the warning triangle out of its box.

- Open the warning triangle to form a closed triangle.
- Release its supports to create a pattern as shown.

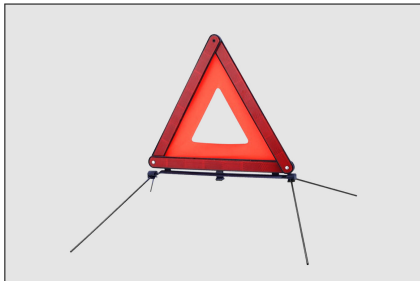

Using Tire Repair Kit

- The tire repair kit is used to seal small cuts, especially cuts in tread pattern. It is just an emergency solution for you to drive to the nearest service center, and only for short emergency stretches, even if the tire is not deflated.

WARNING

- The tire repair kit is only suitable for minor damages of tires. If a wheel is damaged, tyre puncture sealant kit is prohibited.
- Tire sealant is highly flammable and harmful to health. Take the necessary precautions to prevent fire and avoid contact with skin, eyes and clothing; keep away from children; and do not inhale its vapor.

In case of contact with tire sealant:

- If tire sealant comes into contact with the skin or gets into the eyes, thoroughly flush the affected body part immediately with plenty of clean water.
- Change contaminated clothing immediately.

WARNING

- In case of an allergic reaction, seek medical attention immediately.
- If tire sealant is ingested by accident, rinse mouth thoroughly and drink plenty of water immediately. Do not induce vomiting and seek medical attention immediately.

Using the Tire Repair Kit

- Refer to labels on the inflator and tire sealant for usage of the kit.
- If the inflator needs to be connected to a power source, plug the inflator into the vehicle's 12V socket, start the vehicle, and turn on the inflator. The tire sealant is then filled through the inflator hose into the tire along with air.

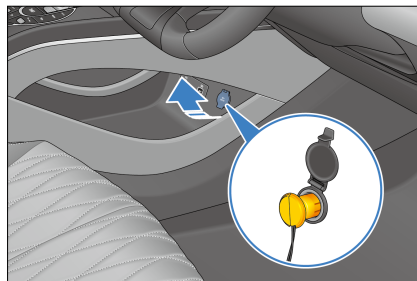

REMINDER

- Make sure the inflator switch is off when you plugging the power supply into the 12V socket in the vehicle.
- The inflator can only be turned on for up to 10 minutes.
- Observe the tire pressure gauge reading on the inflator.

- If the tire pressure does not reach 180 kPa within 10 minutes (red area shown in the figure), turn off the inflator. You are recommended to contact a BYD authorized dealer or service provider.

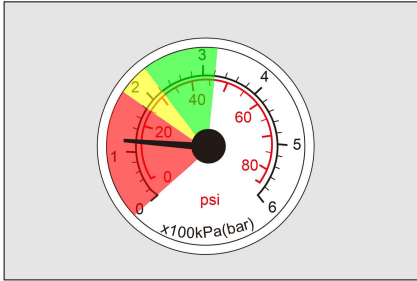

- If the tire pressure reaches between 180 and 320 kPa (green and yellow areas shown in the figure), remove the kit as soon as possible and drive at a speed below 80 km/h within one minute, with the furthest driving distance not exceeding 10 km, so that the tire sealant is evenly distributed within the tire.

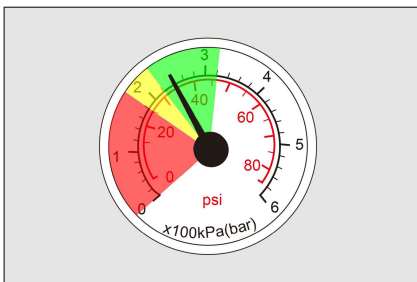

- Observe the tire pressure gauge reading on the inflator.
 - If the tire pressure is greater than 220 kPa, drive to the nearest service center at a speed below 80 km/h.
 - If the tire pressure is between 130 and 220 kPa, repeat the process to fill the tire sealant into the tire and observe the tire pressure gauge reading on the inflator.

- If the tire pressure does not reach 130 kPa, it is recommended to contact a BYD authorized dealer or service provider.

! REMINDER

- Using tire repair kit on damaged tires is only an emergency solution. Please change the tires at a professional repair center as soon as possible. It is recommended that you contact a BYD authorized dealer or service provider and inform the maintenance technician that tire sealant has been used.
- After repairing a tire with the tire repair device, it is recommended that you purchase new tire sealant and inflation hoses at a BYD authorized dealer or service provider.
- Avoid hard acceleration and high-speed turns.
- Do not exceed the 80 km/h maximum speed limit and replace flat tires as soon as possible. Do not drive further if the vehicle experiences strong vibration, unstable performance, or noise.
- When the tire sealant is about to expire (see the label on the canister for exact date), replace it with a new one.

If the Low-Voltage Battery Is Exhausted

When the vehicle cannot start due to under voltage of low voltage distribution box, try to start it as per the following steps:

1. Open the Hood.

2. Remove the left trim panel of front compartment.

3. Connect one end of the red positive (+) cable to the positive (+) terminal of the undercharged low voltage distribution box of the vehicle under rescue.

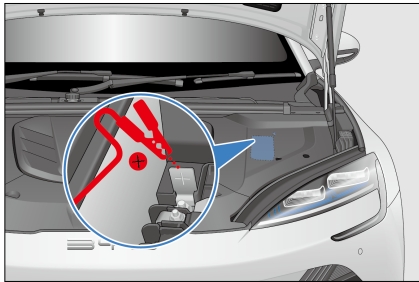

4. Connect the other end of the red positive (+) cable to the positive (+) terminal of the charged low voltage distribution box of the rescue vehicle.

5. Connect one end of the black negative (-) cable to the negative (-) terminal of the charged low voltage distribution box of the rescue vehicle.

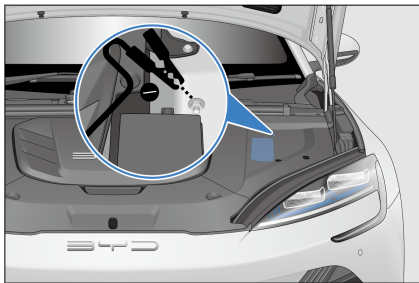

6. Connect the other end of the black negative (-) cable to an applicable tie point (clean, unpainted, solid and grounded metal part) of the vehicle under rescue.

7. Start the rescue vehicle and keep it running for a while. Then try to start the vehicle under rescue.

8. After the vehicle under rescue starts normally, turn off the power of the rescue

vehicle, remove the jumper cables orderly reverse to connection, and put them away.

9. Install the hood trim panel, and close the hood.

WARNING

- Connecting or disconnecting jumper cables in the wrong order may lead to an electrical short circuit, resulting in vehicle damage or personal injury.
- To prevent a short circuit in the jump start, jumper cable clamps shall not contact each other or any conductive material other than the jumper points.

CAUTION

- If the vehicle being rescued cannot be started after several attempts, contact a BYD authorized dealer or service provider.
- The battery rated voltage of the rescue vehicle for jump start shall be 12 V.

If the Vehicle Needs Support

If the vehicle needs to be lifted or jacked, the lifting arm or jack can only be placed at the lifting points as shown in the figure.

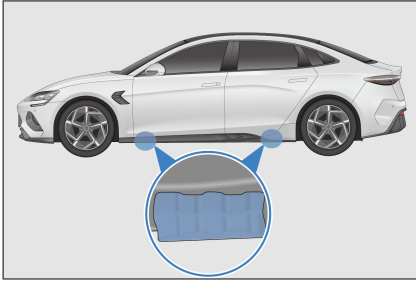

- Pay attention to the followings when lift or jack the vehicle to ensure safety:
 - Park on solid, flat ground.
 - Switch the vehicle power to “OFF” , and all the occupants must get off the vehicle.
 - In case of car slipping, a block should be placed in front of the front wheel or behind the rear wheel when it is jacking up.

 **WARNING**

- Do not place the lifting boom or the jack on the power battery.
- Ensure firmness when lifting or jacking up the vehicle.
- When jacking up the vehicle, do not have any part of your body under the vehicle.

08

SPECIFICATIONS

Data.....	198
Information.....	201
Declarations of Conformity.....	203

Data

Vehicle Data

Vehicle basic parameter

Item	Parameter
Number of occupants (persons)	5
Length (mm)	4800
Width (mm, excluding side mirrors)	1875
Height (mm)	1460
Wheelbase (mm)	2920
Front track (mm)	1620
Rear track (mm)	1625
Front overhang (mm)	885
Rear overhang (mm)	995
Approach angle (°)	13
Departure angle (°)	14

Drive motor

Item	Parameter		
Model	Rear drive extended range	AWD	Rear drive standard range
Drive motor model	Rear control module: TZ200XYC	Front control module: YS210XYA Rear control module: TZ200XYC	Rear control module: TZ200XYL
Drive motor type	Permanent magnet synchronous motor	Front: AC asynchronous motor Rear: Permanent magnet synchronous motor	Permanent magnet synchronous motor
Drive type	Rear control module	AWD	Rear control module

Vehicle power performance and economic efficiency

Item		Parameter	
Model	Rear drive extended range	AWD	Rear drive standard range
Max. design speed (km/h)	180	180	180
Max. gradeability (%)	≥30	≥50	≥30

High-voltage battery

Item	Parameter
Type	Lithium iron phosphate battery
High-voltage battery rated capacity (Ah)	150

Wheels and tires

Item	Parameter
Tire specification	225/50R18; 235/45R19
Tire pressure (kPa)	Front/Rear: 250/290
Wheel dynamic balance requirement (g)	<10

Wheel alignment values (at curb weight)

Item	Parameter
Front camber (°)	-0.5±0.75
Front toe-in (°)	0.05±0.08(side)
Total front wheel toe-in (°)	0.1±0.16
Kingpin inclination angle (°)	8.63±0.75
Kingpin caster angle (°)	6.33±0.75
Rear camber (°)	-1±0.75
Rear wheel toe-in (°)	0.20±0.08(side)
Total rear wheel toe-in (°)	0.40±0.16

Seats:

Item	Parameter
Forward and backward moving spaces for front seat (seat cushion depth measured)	260 mm forward from the end of slide rail travel
Seatback angle of front seats (cushion depth measured)	25°
Normal service conditions of front seatbacks	20° forward and 40° backward from the designated position; 200 mm forward and 60 mm backward from the slide rail; slide rail inclination: 4.5°
Forward and backward moving spaces for rear seat (seat cushion depth measured)	No
Backrest angles of rear seats (seat cushion depth measured)	30°(sides)/27°(middle)
Normal service conditions of seatbacks	Design position (not adjustable)

Fluid

Item	Parameter		
Model	Rear drive extended range	AWD	Rear drive standard range
Front drive gear transmission oil type	-	Castrol BOT-383	-
Front drive gear transmission oil amount (L)	-	2±0.05	-
Rear drive gear transmission oil type	Castrol BOT-383	Castrol BOT-383	Castrol BOT-383
Rear drive gear transmission oil amount (L)	1.5	1.5	1.5
Brake fluid type	HZY6/DOT4	HZY6/DOT4	HZY6/DOT4
Brake fluid amount (L)	1.15±0.05	1.15±0.05	1.15±0.05
Motor controller coolant type	Glycol organic acid long-acting anti-rust antifreeze (-40)	Glycol organic acid long-acting anti-rust antifreeze (-40)	Glycol organic acid long-acting anti-rust antifreeze (-40)
Motor coolant amount (L)	4.8±0.2	5.3±0.2	4.8±0.2

Information

Vehicle Identification

Vehicle Identification Number (VIN)

- ① VIN attached on the right of the front anti-impact beam
- ② VIN attached under the front hood inner panel
- ③ VIN attached on the front windshield cross sill
- ④ VIN attached on the front side of the rear motor

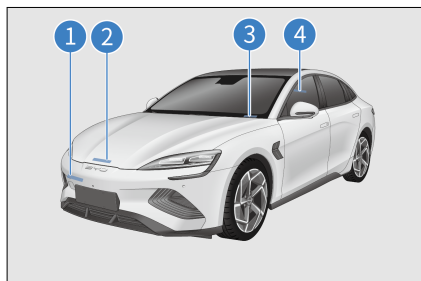

- ⑤ VIN attached on the sheet metal surface at the lower corner of front left door
- ⑥ VIN attached on the left rear door sill
- ⑦ VIN attached on the left rear wheel hubcap metal

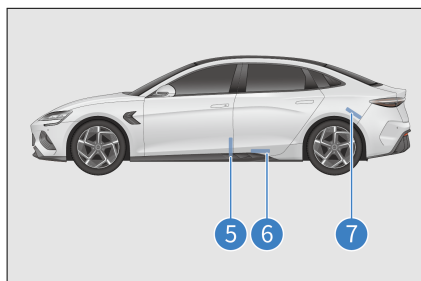

- ⑧ VIN attached inside the right trunk lid

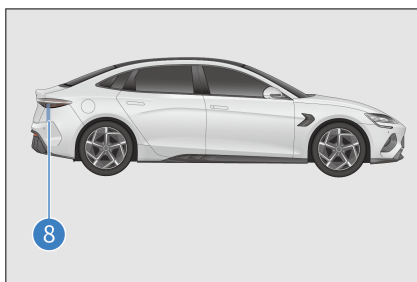

VIN is engraved on the lower beam of the front right seat.



Note: After connecting the VDS, the VIN can be found in the upper right corner of the screen for the corresponding model. For details, please refer to the VDS operation manual.

Vehicle Nameplate

The vehicle nameplate is located at the lower sheet metal sink of the right B-pillar.

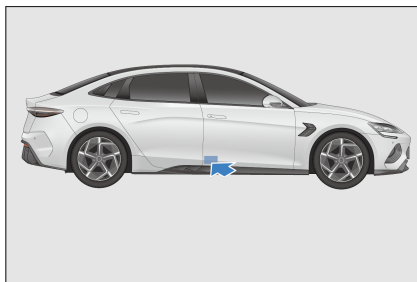

Model and Serial Number of Drive Motor

- ① The model and serial number of front drive motor are engraved on the front drive motor housing*.
- ② The model and serial number of rear drive motor are engraved on the rear drive motor housing.

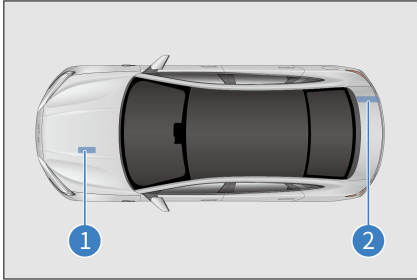

The airbag warning label is printed on the front passenger's sun visor.

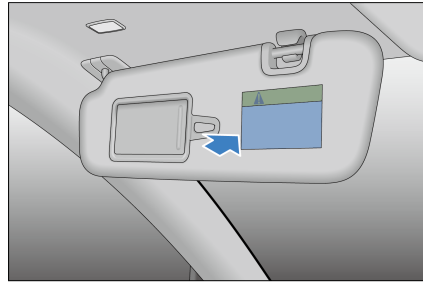

Warning Labels

- ① A/C system and cooling fan label
- ② Battery position label

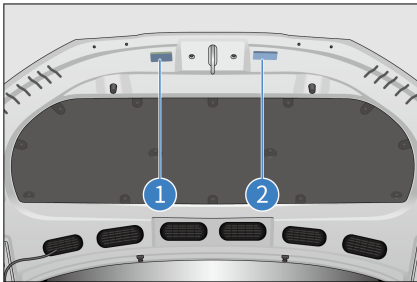

The side airbag warning labels are attached below the left and right B-pillar and C-pillar.

⚠ WARNING

- Do not use rear-facing children restraint device in front of the seats with active airbags protection.
- It may cause children death or severe injury.

The tire pressure label is attached below the left B-pillar.

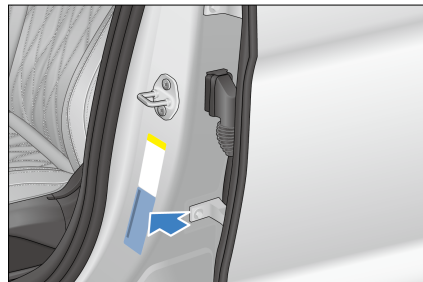

The charging warning label is attached to the inner side of the charging port hatch.

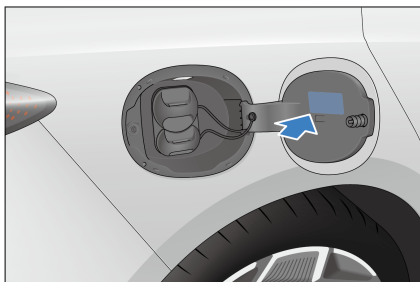

⚠ CAUTION

- Do not overlap with the glass frame or other objects when attaching the electronic logo.

Declarations of Conformity

Smart Key

Transponder Mounting

The transponder mounting position is located in the upper left of the front windshield.



Uzbekistan

Model: D1-92

This equipment is not entitled to protection against harmful interference and may not cause interference to duly authorized systems.



EU countries

Model: D1-92

This equipment is not entitled to protection against harmful interference and may not cause interference to duly authorized systems.



Brazil

Model: D1-92

This equipment is not entitled to protection against harmful interference and may not cause interference to duly authorized systems.



Japan

Model: D1-315

This equipment is not entitled to protection against harmful interference and may not cause interference to duly authorized systems.

MmWave radars



EU countries

Certificate ID: T.2021.08.0001

This equipment is not entitled to protection against harmful interference and may not cause interference to duly authorized systems.



Japan

Certificate ID: 219-210015

This equipment is not entitled to protection against harmful interference and may not cause interference to duly authorized systems.



Brazil

Certificate ID: 15210-21-03745

This equipment is not entitled to protection against harmful interference and may not cause interference to duly authorized systems.

Numerics

12V Auxiliary Power..... 157

A

A/C Operation Interface..... 147

A/C Panel..... 147

A/C Settings..... 154

A/C System Maintenance..... 176

Acoustic Vehicle Alerting System

(AVAS)..... 129

Adaptive Cruise Control (ACC)..... 109

Air Purification System..... 152

Airbags..... 15

Anti-lock Braking System (ABS)... 137

Anti-theft Alarm System..... 28

Automatic Anti-glare Rearview Mirror
..... 141

Automatic Vehicle Hold (AVH)..... 106

B

Battery Leakage Rescue..... 189

Before Charging..... 80

Bill Box..... 156

Blind Spot Assist (BSA)..... 125

Brake fluid..... 175

Break-in Period..... 94

C

Carrying Luggage..... 97

Charge Port Anti-theft Lock..... 88

Charging Reservation (Only AC).... 85

Charging Safety Warning..... 76

Child Presence Detection (CPD)... 140

Child Protection Lock..... 57

Coolant..... 174

Cubby Box..... 155

D

Data Collection and Processing..... 29

Discharging Device..... 87

Driver Attention Warning (DAW)*. 139

Driver's Door Switches..... 69

Driving Precautions..... 107

Driving Safety Precautions..... 95

Driving Safety Systems..... 135

E

Electric Side Mirrors..... 141

Electronic Parking Brake (EPB).... 104

Electronic Smart Key..... 46

Emergency Call (E-Call)..... 73

Emergency lane keeping assist... 124

Emergency Shutdown System..... 188

Emergency Vehicle Locking with
Mechanical Key..... 55

F

File Pockets..... 156

Fire Prevention..... 99

Front Cross Traffic Alert (FCTA) &
Front Cross Traffic Braking (FCTB)....
117

Front Seat Cup Holder..... 155

Function Definition..... 149

Fuses..... 180

G

Gear Shift Controls..... 103

Glove Box..... 154

Grab Handles..... 157

H

Hazard Warning Light Switch..... 73

Head-up Display (HUD)*..... 127

High Beam Assist..... 121

High-Voltage Battery..... 91

I

If a Tire Goes Flat..... 191
If Smart Key Battery Is Exhausted 188
If the Vehicle Needs Towing..... 190
Indicators and Warning Lights..... 36
Installing Child Restraint Systems. 24
Intelligent Cruise Control (ICC).... 113
Intelligent speed limit control..... 120
Interior Cleaning..... 170
Interior Light Switch..... 74

L

LCD Instrument Cluster..... 34
Light Switches..... 65
Locking/Unlocking with Mechanical
Key..... 48
Low-voltage Battery..... 93

M

Maintenance Plan..... 162
Maintenance Plan Requirements. 162

O

Odometer Switch..... 71
Opening the Hood..... 174

P

Paint Maintenance Tips..... 168
Panoramic View System..... 130
Power-Assisted Steering Mode
Settings..... 65
Predictive Emergency Braking (PEB)
System..... 115

R

Regular Maintenance..... 167

S

Saving Energy and Extending Vehicle
Service Life..... 97
Seat Information..... 58
Self-Maintenance..... 171
Smart Access and Start System..... 55
Snow Chains..... 101
Starting the Vehicle..... 102
Steering Wheel Switches..... 62
Storage Box on Interior Panel..... 156
Suggestions for Vehicle Use..... 96
Sun Visor..... 156

T

Tire Pressure Monitoring..... 128
Tires..... 177
Traffic Sign Recognition System.. 119
Trailer Towing..... 95
Transponder Mounting Position.. 203

U

USB Charge Port..... 157
Using Seat Belts..... 12

V

Vehicle Cleaning..... 169
Vehicle Corrosion Prevention..... 168
Vehicle Fire Rescue..... 189
Vehicle Identification Number (VIN)
..... 201
Vehicle Storage Precautions..... 173
Vents..... 151

W

Wading into Water.....	98
Warning Label.....	202
Washer.....	175
Winter Driving Precautions.....	108
Wiper Blades.....	176
Wiper Switch.....	68
Wipers.....	142
Wireless Phone Charger.....	158

Abbreviation List

Abbreviations

Terminology	Name	Terminology	Name
ECU	Electronic Control Unit	EPB	Electronic Parking Brake
ESC	Electronic Stability Controller	SOC	State of Charge
ACC	Adaptive Cruise Control	AEB	Automatic Emergency Braking
FCTB	Front Cross Traffic Braking	FCTA	Front Cross Traffic Alert
BSD	Blind Spot Detection	RCTA	Rear Cross Traffic Alert
RCTB	Rear Cross Traffic Braking	RCW	Rear Collision Warning
DOW	Door Open Warning	AVAS	Acoustic Vehicle Alert System
TCS	Traction Control System	VDC	Vehicle Dynamics Control
HHC	Hill Descent Control	HBA	Hydraulic Brake Assist
ABS	Anti-lock Braking System	MAX	Maximum
MIN	Minimum		

